

MULTIPLE COMPACT DISC PLAYER  
**CD-2260M/DPF-J7010**  
**CD-2280M/DPF-J9010**  
**SERVICE MANUAL**

**KENWOOD**

© 1998-3/B51-5416-00 (K/K) 3094

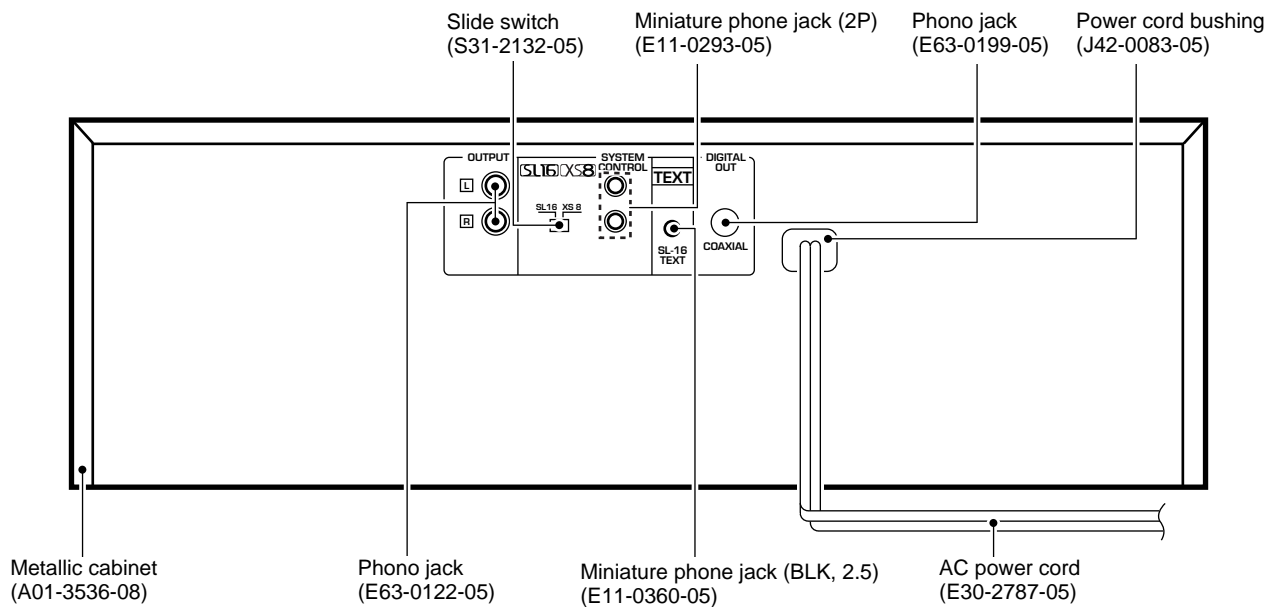
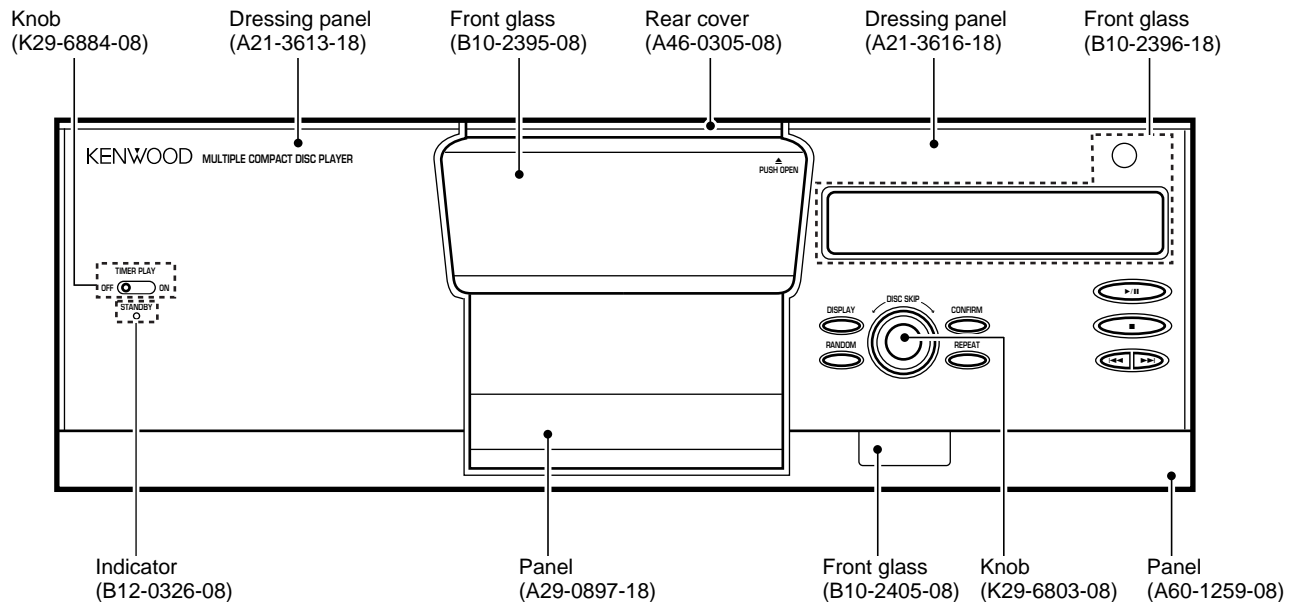

**Illustration is CD-2260M.**

In compliance with Federal Regulations, following are reproductions of labels on, or inside the product relating to laser product safety.

KENWOOD-Crop. certifies this equipment conforms to DHHS Regulations No. 21 DFR 1040. 10, Chapter 1, Subchapter J.

**DANGER : Laser radiation when open and interlock defeated. AVOID DIRECT EXPOSURE TO BEAM**

Please refer to the service manual **CD-223M/DPF-J3010/CD-224M/DPF-J5010 (B51-5409-00)** if need more information.



## CONTENTS / ACCESSORIES

### Contents

CONTENTS / ACCESSORIES .....	2	PC BOARD .....	11
EXTERNAL VIEW .....	3	SCHEMATIC DIAGRAM .....	15
DISASSEMBLY FOR REPAIR .....	4	EXPLODED VIEW .....	26
CONTROLS .....	5	PARTS LIST .....	28
CIRCUIT DESCRIPTION .....	7	SPECIFICATIONS .....	Back cover
ADJUSTMENT .....	10		

### Accessories

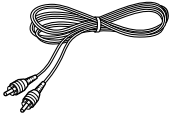
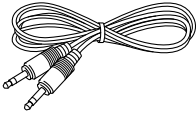
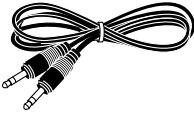
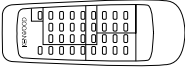
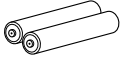
<p>Audio cord ..... (1) (E30-0505-05)</p> 	<p>System control cord ..... (1) (E30-2816-05)</p> 	<p>Communication cord ..... (1) (E30-2861-05)</p> 
<p>Remote control unit ..... (1) * (A70-1174-08) : RC-P0506 (A70-1175-08) : RC-P0306</p> 	<p>Batteries (R6/AA) ..... (2)</p> 	
<p>Battery cover (A09-0374-08)</p>		<p>* Refer to parts list on page 28.</p>

### Beware of condensation

When water vapor comes into contact with the surface of cold material, water drops are produced.

If condensation occurs, correct operation may not be possible, or the unit may not function correctly.

This is not a malfunction, however, and the unit should be dried. (To do this, turn the POWER switch ON and leave the unit as it is for several hours.)

Be especially careful in the following conditions:

- When the unit is brought from a cold place to warm place, and there is a large temperature difference.
- When a heater starts operating.
- When the unit is brought from an air-conditioned place to a place of high temperature with high humidity.
- When there is a large difference between the internal temperature of the unit and the ambient temperature, or in conditions where condensation occurs easily.

### Note related to transportation and movement

Before transporting or moving this unit, carry out the following operation:

1. Remove all discs from the carousel and close the door panel.
2. Confirm that the flashing "NO DISC" display has changed to steady lighting, and then switch off the power.



3. Wait a few seconds, then disconnect the power plug.

### Operation to reset

The microcomputer may malfunction (impossibility to operate, erroneous display, etc.) when the connection cords are unplugged while power is ON or due to an external factor. In this case, execute the following method to reset the microcomputer and return it to normal condition.

**Unplug the power cord from the power socket and plug the power cord into the socket again.**

### To reset the registered contents

The registered contents for title name, music type, and best selection can be reset by the following procedure.

**Unplug the power cord from the power socket and, while holding the ■ key depressed, plug the power cord into the socket again.**

# CD-2260M/2280M/DPF-J7010/J9010

## EXTERNAL VIEW

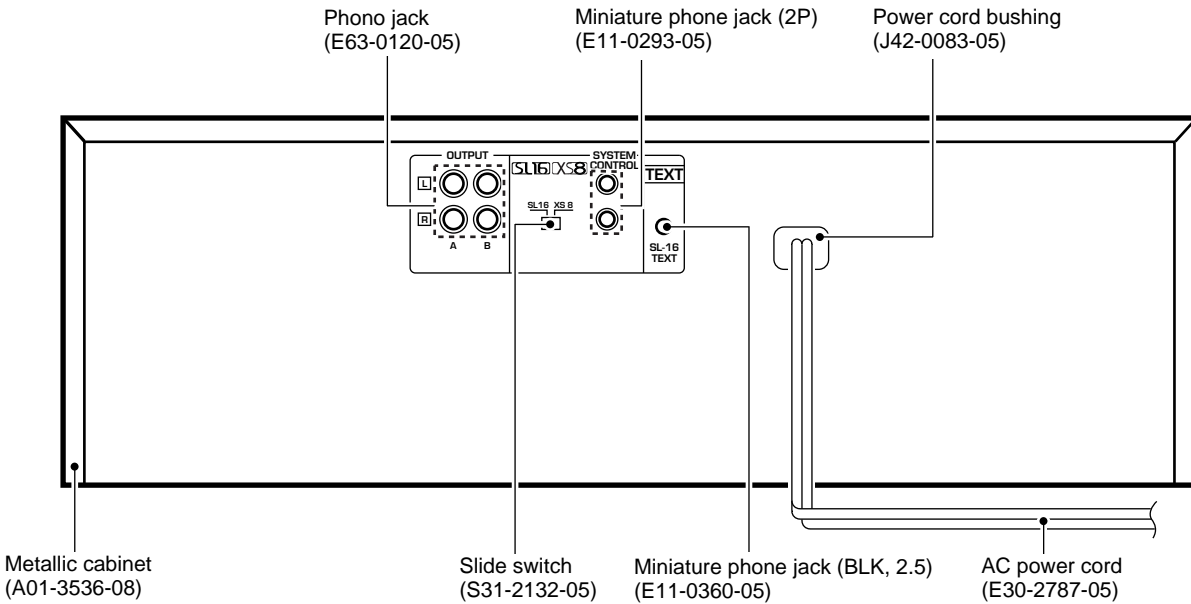
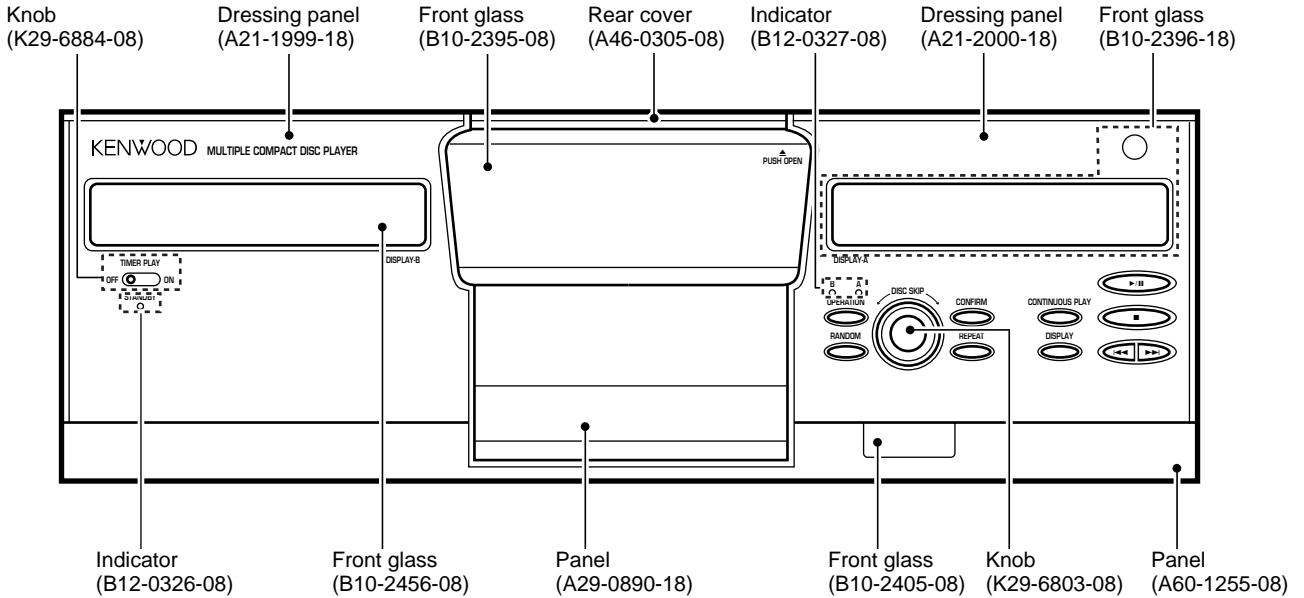
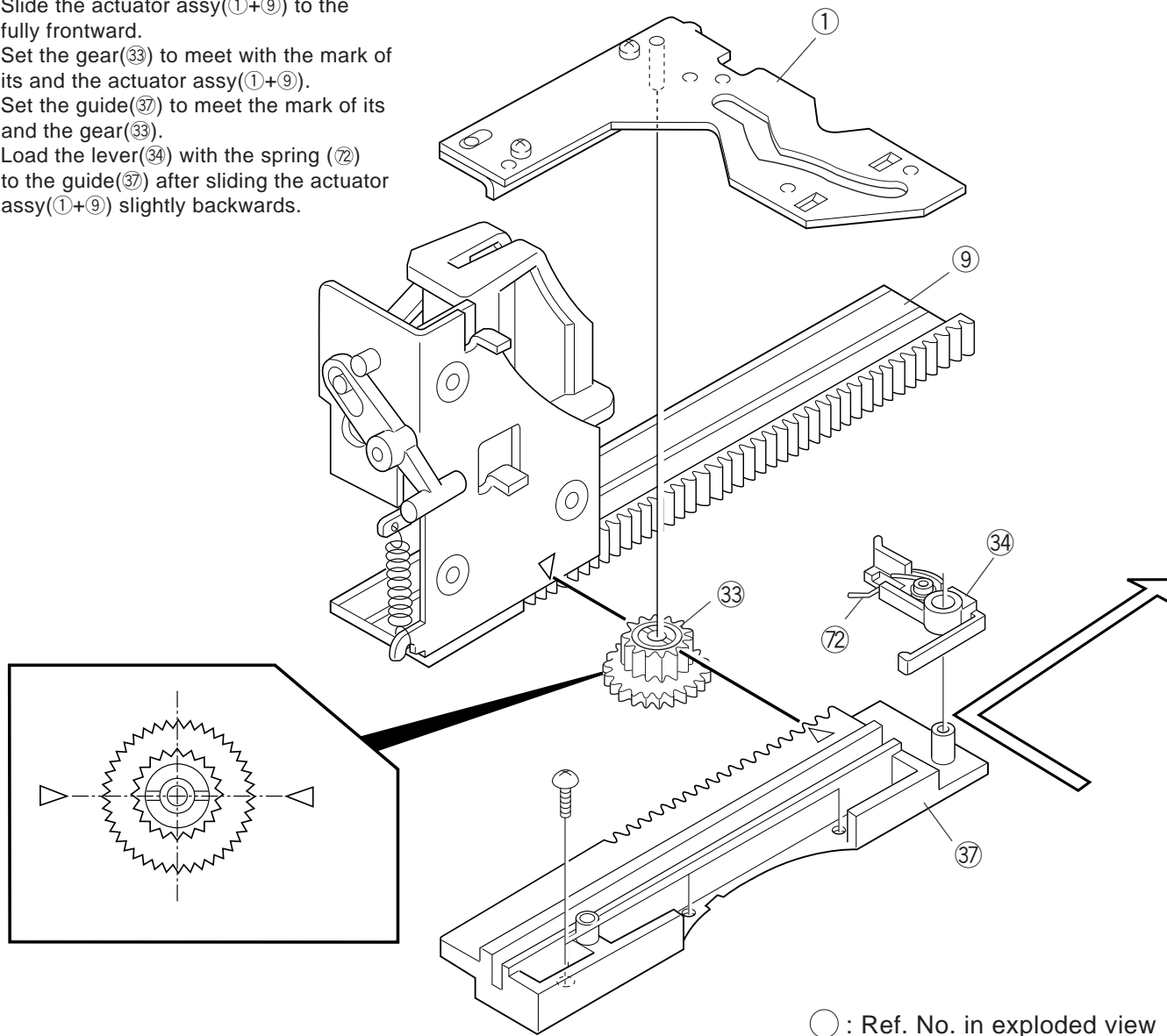

Illustration is CD-2280M.

## DISASSEMBLY FOR REPAIR

### How to Assemble Mechanism.

1. Remove the lever(34) with the spring (72).
2. Slide the actuator assy(1+9) to the fully frontward.
3. Set the gear(33) to meet with the mark of its and the actuator assy(1+9).
4. Set the guide(37) to meet the mark of its and the gear(33).
5. Load the lever(34) with the spring (72) to the guide(37) after sliding the actuator assy(1+9) slightly backwards.



## CONTROLS

### CD-2260M/DPF-J7010

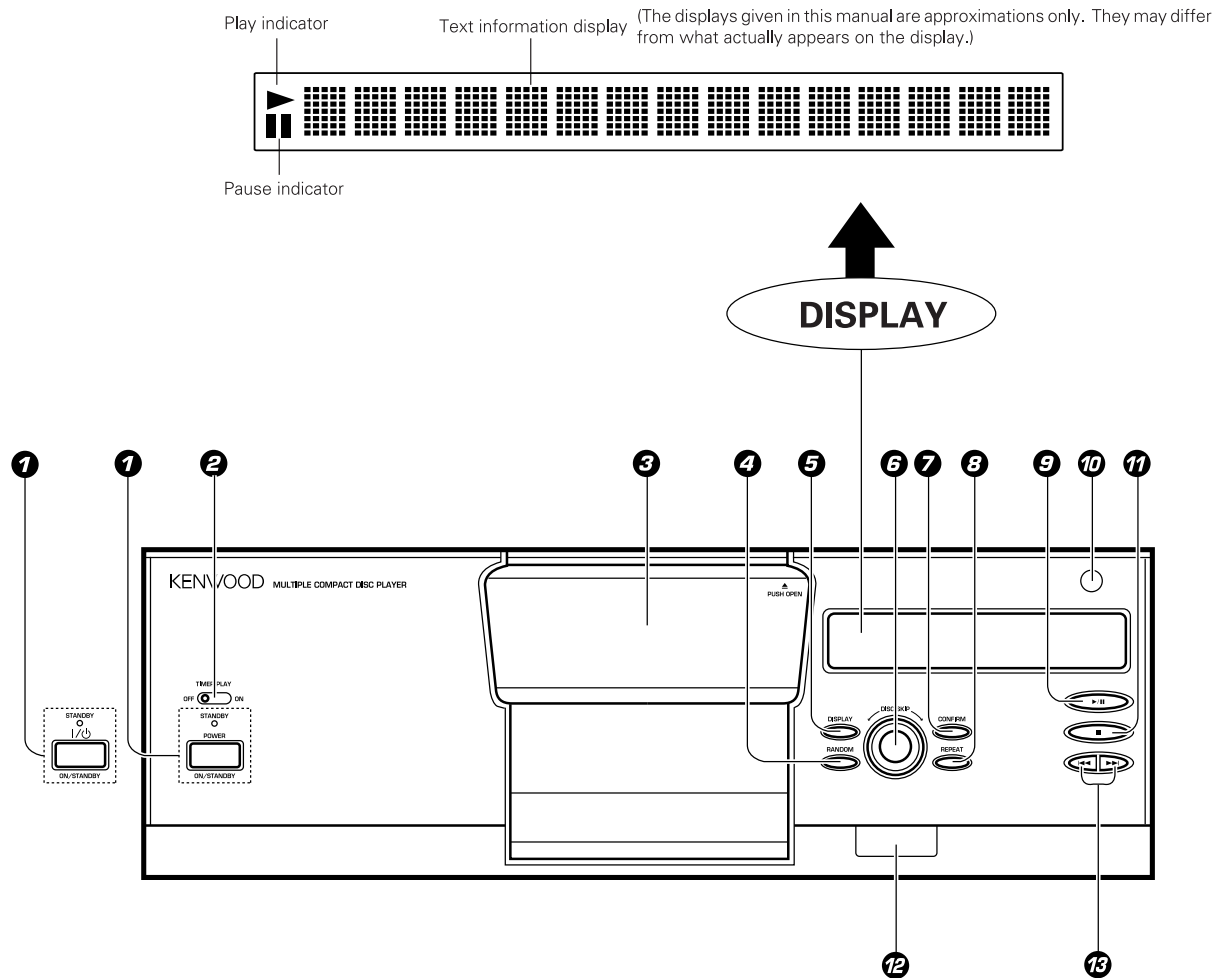

**1 POWER key/STANDBY indicator (For the U.S.A. and Canada)**  
**I / ⏻ key/STANDBY indicator (For other countries)**

**2 TIMER PLAY switch**  
 Used for timer play ON/OFF.

**3 Door panel**

**4 RANDOM key**  
 Press to start random playback.

**5 DISPLAY key**  
 Switching between title display and time display.

**6 DISC SKIP knob**  
 Used for disc selection. Characters are selected at the time of title registration.

**7 CONFIRM key**  
 The present playback mode is displayed.

**8 REPEAT key**  
 Press to start repeated playback.

**9 Play/Pause key (▶/⏸)**

**10 Remote sensor**

**11 Stop key (■)**

**12 LCD remote control signal transmitter**  
 The disc and track title data are output to the LCD remote control unit (provided with a KENWOOD Receiver) through this window.

**13 Skip keys (◀◀ ▶▶)**  
 Press to skip to the beginning of another track. Characters are selected at the time of title registration.

### About the STANDBY mode

While the STANDBY indicator is lit, a small amount of power is supplied to the system to back up the memory. This is called the standby mode. Under that condition, the system can be turned ON by the remote control unit.

# CD-2260M/2280M/DPF-J7010/J9010

## CONTROLS

### CD-2280M/DPF-J9010

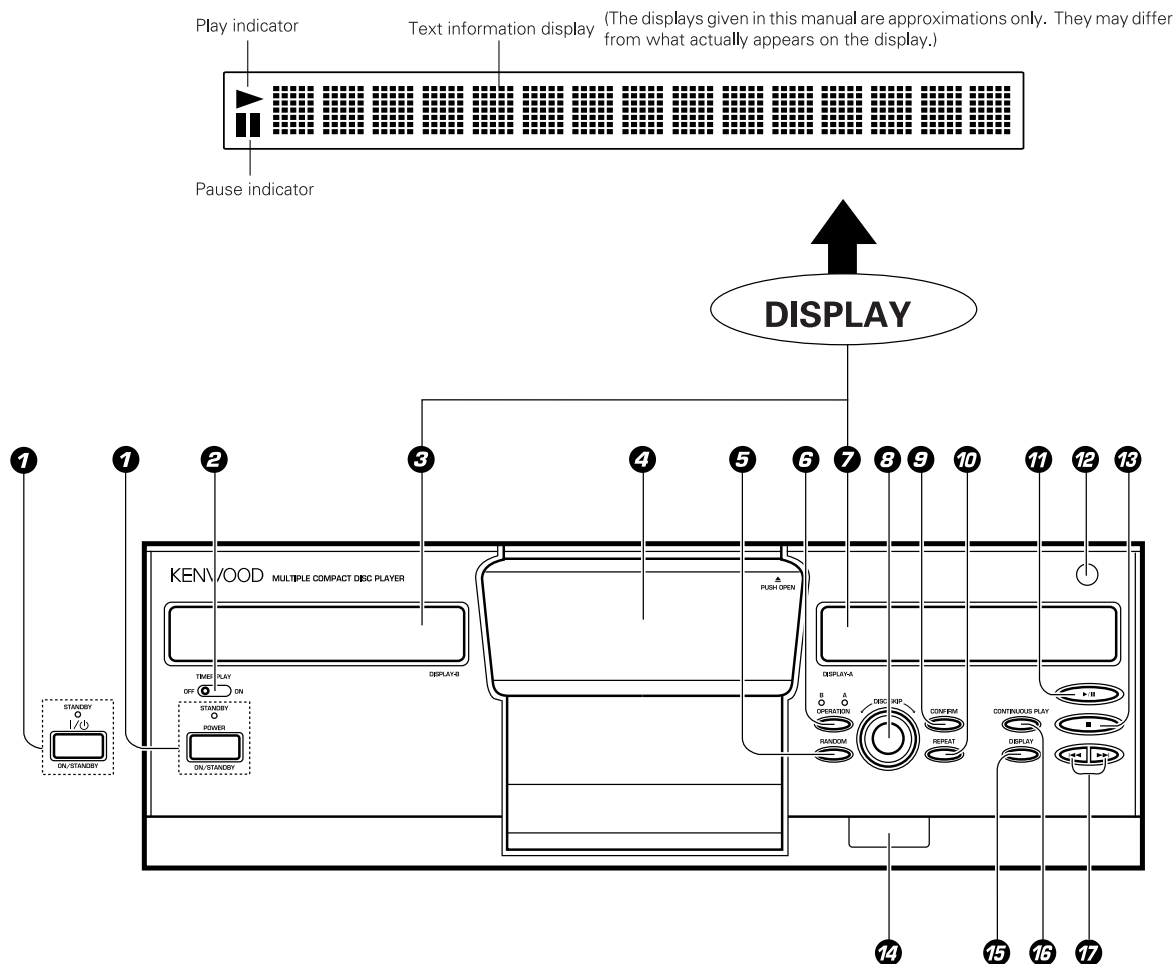

**1 POWER key/STANDBY indicator (For the U.S.A. and Canada)**  
**I / ⏻ key/STANDBY indicator (For other countries)**

**2 TIMER PLAY switch**  
Used for timer play ON/OFF.

**3 Mechanism-B display**

**4 Door panel**

**5 RANDOM key**  
Press to start random playback.

**6 OPERATION A-B key**  
Press to switch between mechanisms A and B. While the B indicator is lit, only the key on the main unit is valid.

**7 Mechanism-A display**

**8 DISC SKIP knob**  
Used for disc selection. Characters are selected at the time of title registration.

**9 CONFIRM key**  
The present playback mode is displayed.

**10 REPEAT key**  
Press to start repeated playback.

**11 Play/Pause key (▶/⏸)**

**12 Remote sensor**

**13 Stop key (■)**

**14 LCD remote control signal transmitter**  
The disc and track title data are output to the LCD remote control unit (provided with a KENWOOD Receiver) through this window.

**15 DISPLAY key**  
Switching between title display and time display.

**16 CONTINUOUS PLAY key**  
Used for continuous play mode switching.

**17 Skip keys (◀◀ ▶▶)**  
Press to skip to the beginning of another track. Characters are selected at the time of title registration.

### About the STANDBY mode

While the STANDBY indicator is lit, a small amount of power is supplied to the system to back up the memory. This is called the standby mode. Under that condition, the system can be turned ON by the remote control unit.

## CIRCUIT DESCRIPTION

### 1. Sub processor : uPD780023GC501 (IC3 : X25)

#### Pin description

Pin No.	Pin Name	I/O	Description
1	SLT-SW	I	Start limit sw input.
2	LDC	O	Laser on/off control.
3	MON	O	Spindle motor on/off control.
4	FOK	I	Focus ok signal input.
5	GFS	I	GFS input from CXD2587Q.
6	SENS	I	Sense output from CXD2587Q.
7	CLOCK	O	Clock output to CXD2587Q.
8	XLAT	O	Latch output to CXD2587Q.
9	VSS	-	GND.
10	VDD	-	Power supply(+5V).
11~14	-	-	No use.
15	DATA	O	Serial data output.
16	MUTEG	O	Mute control port.
17	SCLK	O	Clock output for SENSE serial data read out.
18	SQSO	I	Sub Q/PCM peak/level data input.
19	-	-	No used.
20	SQCK	O	Clock output for SQCK read out.
21	RXD-S	I	UART communication input from main microprocessor.
22	TXD-S	O	UART communication output to main microprocessor.
23	-	-	No use.
24	VDD	-	Power supply(+5V).
25	VDSS	-	GND.
26~33	-	-	GND.
34	AVREF	-	GND.
35	AVDD	-	Power supply(+5V).
36	RESET	I	Reset signal input.
37	XT2	-	No connection.
38	XT1	-	Power supply(+5V).
39	VSS	-	GND.
40	X2	-	Clock(8.38MHz).
41	X1	I	Clock(8.38MHz).
42	VSS	-	GND.
43	SCOR	I	Input port of sub-code synchro.
44	A2-SW	O	Main unit audio out -- Sub output port.
45	A1-SW	O	Sub unit audio out --- Main output port.
46	RMUTE2	O	Analog mute control.
47~61	-	-	No used.
62~64	-	-	Power supply(+5V).

## CIRCUIT DESCRIPTION

### 2. TEST MODE

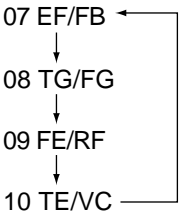
INPUT KEY	PROCEDURE	DISPLAY
Insert the AC plug to the wall outlet with pressing the SKIP-DOWN key.	INITIAL CONDITION <ul style="list-style-type: none"> <li>• Disc No.1 moves to the center and clamp it.</li> <li>• Clear the memory of the SRAM.</li> <li>• Door opens.</li> <li>• Set the switch of TIMER ON PLAY to ON.</li> <li>• Set the switch of SYSTEM CONTROL to XS8.</li> </ul>	INITIAL OK!! MECH. INITIAL  INITIAL NG TIMER, NG SER, NG
Insert the AC plug to the wall outlet with pressing the REPEAT or CONTINUOUS PLAY key.(J9010)	CIRCUIT ADJUSTMENT <ul style="list-style-type: none"> <li>• Open the door and load the disc to the Disc No.1 in mechanismA. Also No.3 in mechanismB.</li> <li>• Close the door. The unit changes to test mode"05" after clamping the discs on both mechanismA and B.</li> </ul>	TEST ON
Caution:Not clear the memory of the SRAM if pressed CONTINUOUS PLAY key.(J9010)		
Insert the AC plug to the wall outlet with pressing the REPEAT key(J7010)	CIRCUIT ADJUSTMENT <ul style="list-style-type: none"> <li>• Open the door and load the disc to the Disc No.1.</li> <li>• Close the door. The unit changes to test mode"05" after clamping the disc.</li> </ul>	TEST ON
PLAY/PAUSE	Change the mode 05(tracking-on) and 03(tracking-off) alternately by the PLAY key.	05 1:23      03 2:34
STOP	Stop the function.	00
UP(mechanismA only)(J9010)	The pickup travels outwards.	MOTOR FORWARD
UP(J7010)	The pickup travels outwards.	MOTOR FORWARD
DOWN(mechanismB only)(J9010)	The pickup travels inwards.	MOTOR REVERSE
DOWN(J7010)	The pickup travels inwards.	MOTOR REVERSE
RANDOM	Shows the result of self-adjustment. 	07 XXX:XXX 08 XXX:XXX 09 XXX:XXX 10 XXX:XXX NG: blinking
DISPLAY	-	shows niagara mode
POWER	Check the transmission signal(Disc No.1 and Track No.99) of the remote controller.	
OPERATION(J9010)	Mechanism selection A or B.	
REPEAT(mechanismA only)(J9010)	Playback PGM signal of the Track No.7,13,23,30,34 and 41 in the order. And release the test mode in both mechanisms.	
REPEAT(J7010)	Playback PGM signal of the Track No.7,13,23,30,34 and 41 in the order. And release the test mode.	
CONFIRM(J9010)	Release the test mode on both mechanisms.	
CONFIRM(J7010)	Release the test mode.	
(TIMER PLAY SW)	Check the switch position.	TIMER ON , TIMER OFF
(SL16/XS8 SW)	Check the switch position.	16BIT, 8BIT
(TxD port)	Check the SL16-TEXT port. TxD:H → RxD:L, TxD:L → RxD:H	
Insert the AC plug to the wall outlet with pressing the UP key.	CHECK THE MECHANISM JAMMING. Clamp the Disc No1,2,100,50,200 and 199 in the order.	
Insert the AC plug to the wall outlet with pressing the RANDOM key.	THE MECHANISM TEST MODE. Display shows NIAGARA until pressing any key.	
PLAY/PAUSE	Change the mode 05(tracking-on) and 03(tracking-off) alternately by the PLAY key.	05 1:23      03 2:34



## CIRCUIT DESCRIPTION

INPUT KEY	PROCEDURE	DISPLAY
STOP	Stop the function. Shows the result of self-adjustment. 07 EF/FB ← ↓ 08 TG/FG ↓ 09 FE/RF ↓ 10 TE/VC ——— Mode changes alternately by the STOP key.	07 XXX:XXX  08 XXX:XXX  09 XXX:XXX  10 XXX:XXX NG: blinking
UP(J9010)	Arm Motor Load operation in mechanismA. ----- The pickup travels outwards In mechanismB.	MOTOR LOAD ----- MOTOR FORWARD
UP(J7010)	Arm Motor Load operation.	MOTOR LOAD
DOWN(J9010)	Arm Motor Unload operation in mechanismA. ----- The pickup travels inwards in mechanismB.	MOTOR UNLOAD ----- MOTOR REVERSE
DOWN(J7010)	Arm Motor Unload operation.	MOTOR UNLOAD
RANDOM	Rotary Motor Clockwise turning.	MOTOR CW
DISPLAY	Rotary Motor Counterclockwise turning.	MOTOR CCW
POWER	Check the transmission signal(Disc No.1 and Track No.99) of the remote controller.	
OPERATION(J9010)	Mechanism selection A or B.	
REPEAT(mecanismA only)(J9010)	Playback PGM signal of the Track No.7,13,23,30,34 and 41 in the order. And release the test mode in both mechanisms.	
REPEAT(J7010)	Playback PGM signal of the Track No.7,13,23,30,34 and 41 in the order. And release the test mode.	
CONFIRM(J9010)	Release the test mode on both mechanisms.	
CONFIRM(J7010)	Release the test mode.	
(TIMER PLAY SW)	Check the switch position.	TIMER ON , TIMER OFF
(SL16/XS8 SW)	Check the switch position.	16BIT, 8BIT
(TxD port)	Check the SL16-TEXT port. TxD:H → RxD:L, TxD:L → RxD:H	

J9010: CD-2280M or DPF-J9010.  
 J7010: CD-2260M or DPF-J7010.

### 3. ERROR CODE

DISPLAY	ERROR CONTENTS
MECHA ERROR 01	No input of S3. The original position error of Disc Number.
MECHA ERROR 02	No input of S2. The turning direction error to counterclockwise
MECHA ERROR 03	No input of S1. The turning direction error to clockwise
MECHA ERROR 04	No input of main load sw.
MECHA ERROR 05	No input of main unload sw.
MECHA ERROR 06	No input of sub load sw. (DPF-J9010)
MECHA ERROR 07	No input of sub unload sw. (DPF-J9010)

S1-3: Mechanism address detector switch.  
 There are load and unload switches in the main pickup.

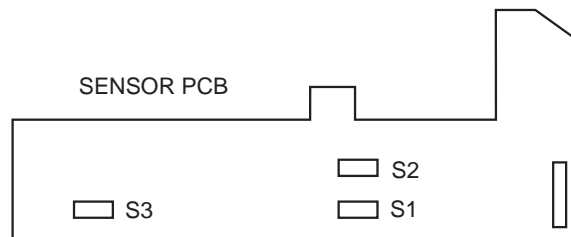

S1 DISC 1~9  
 S2 DISC 10~99  
 S3 DISC 100~200

## ADJUSTMENT

No.	ITEM	INPUT SETTING	OUTPUT SETTING	PLAYER SETTING	ALIGNMENT POINT	ALIGN FOR	
1. With pressing the RANDOM KEY, turn the power on to enter the test mode. 2. Set the Test disc to Disc NO. 1. 3. Close the door.							
1	FOCUS ERROR BIAS	Test disc Type4 /KTD-02	Connect an oscilloscope as follows. CH1:RF (CN2-1)	Press the PLAY /PAUSE key . Confirm that the display is "05".	FE BIAS VR1	Optimum eye pattern	(a)

Note:

Type 4 disc :SONY YEDS-18 Test Disc or equivalent.

LPF : Around 47kΩ + 390 pF or so.

FIG. (a)

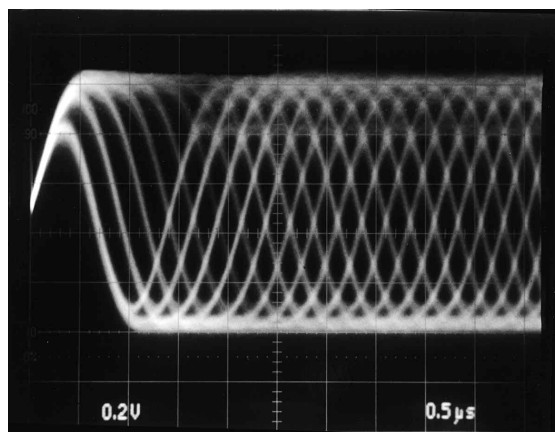

RF signal

- RF signal in test mode (PLAY).
- Perform the tangential and focusing offset are focused into one point on the display. The crossing points above and below the center shall also be looked clearly. (FE BIAS)

# PC BOARD (Component side view)

X32-3500-10 A/8 (J70-1122-11)

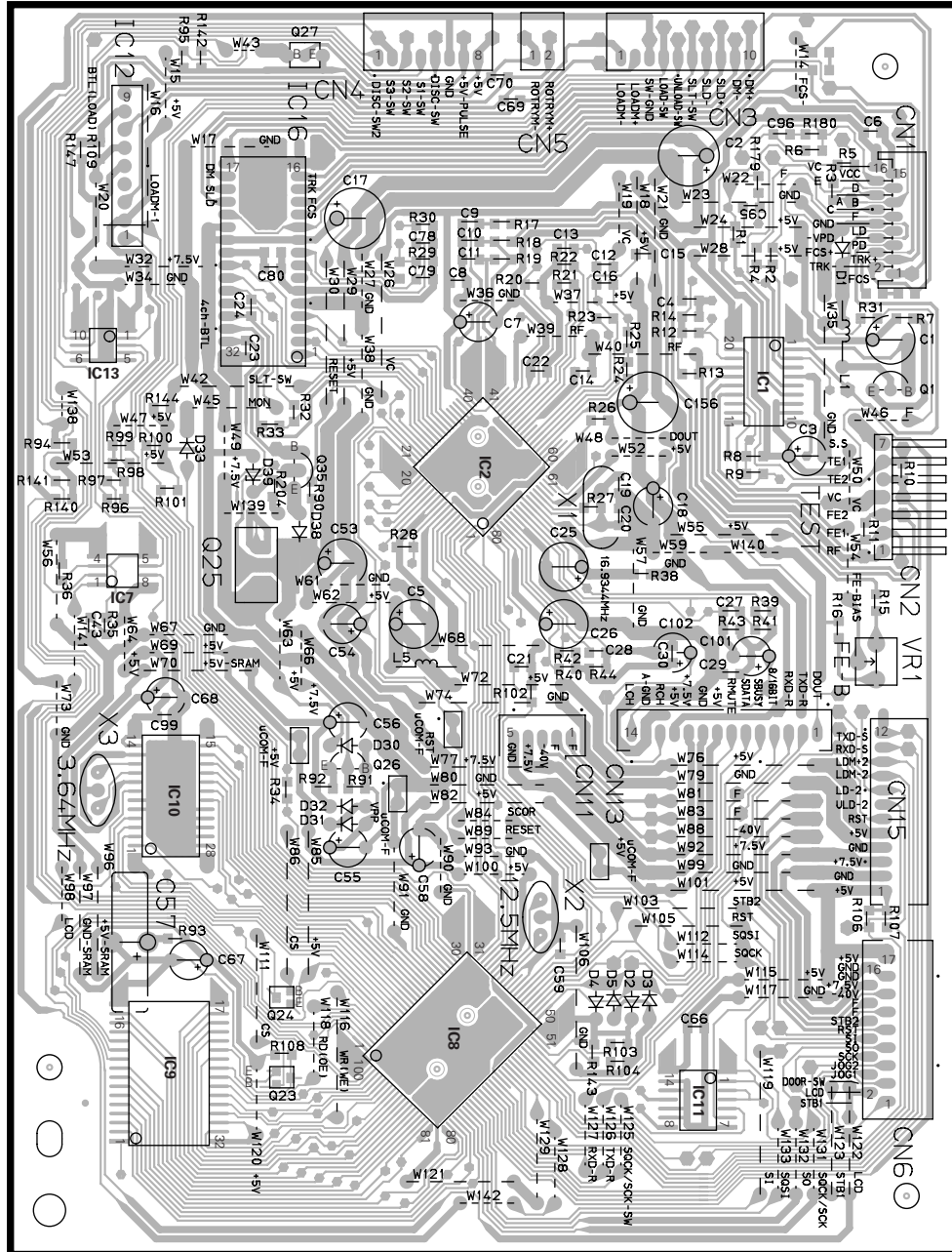

Refer to the schematic diagram for the value of resistors and capacitors.



# PC BOARD (Component side view)

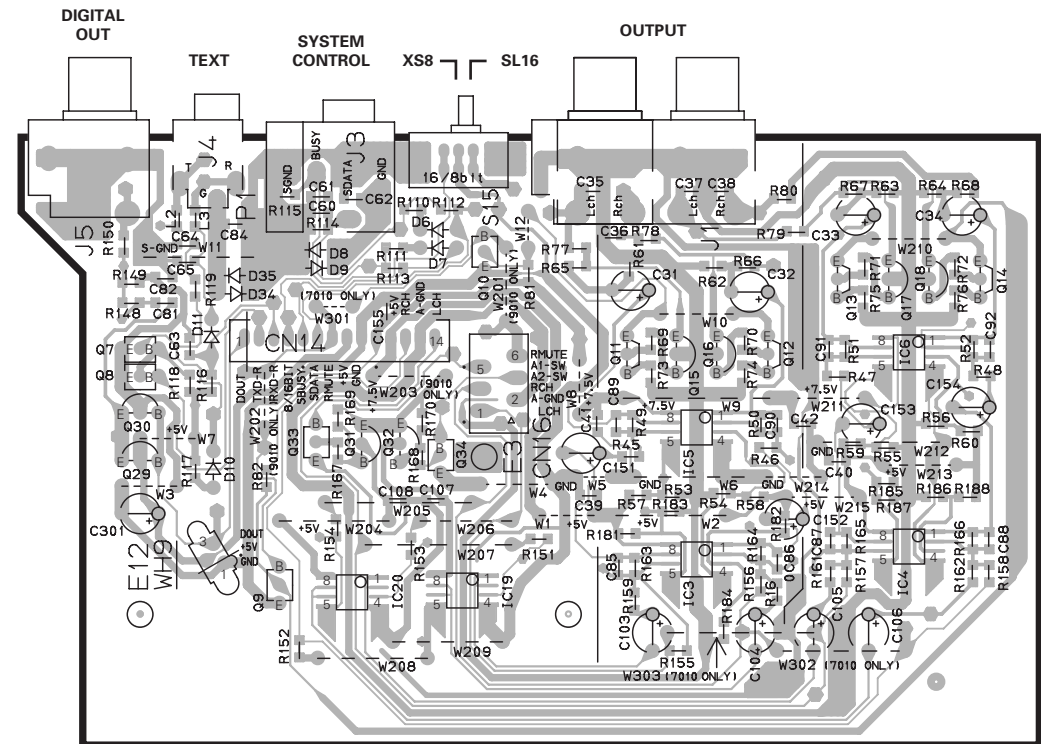

X32-3500-10 B/8 (J70-1122-11)

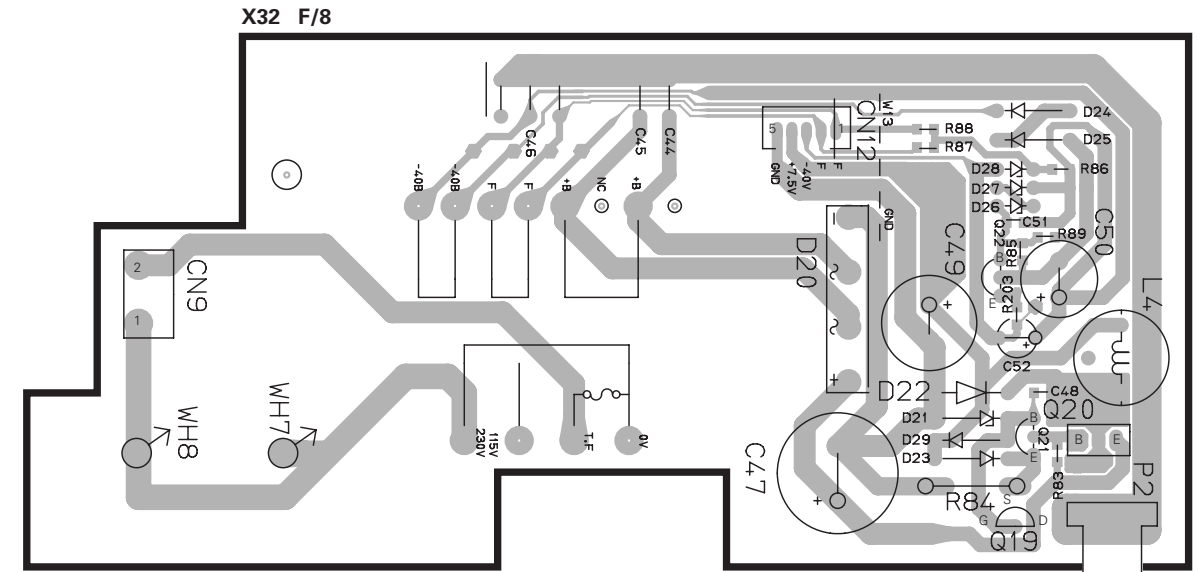

X32 E/8

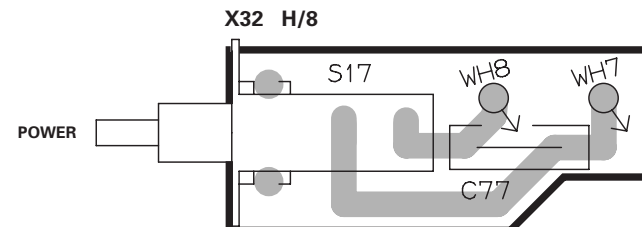
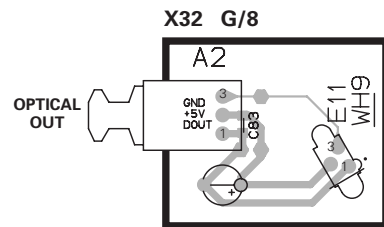
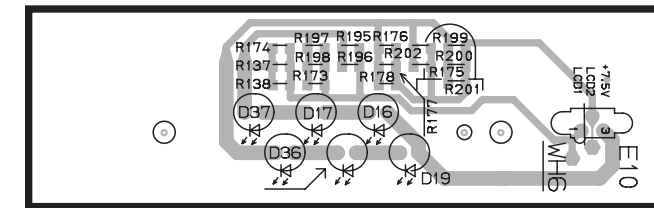

X32 D/8

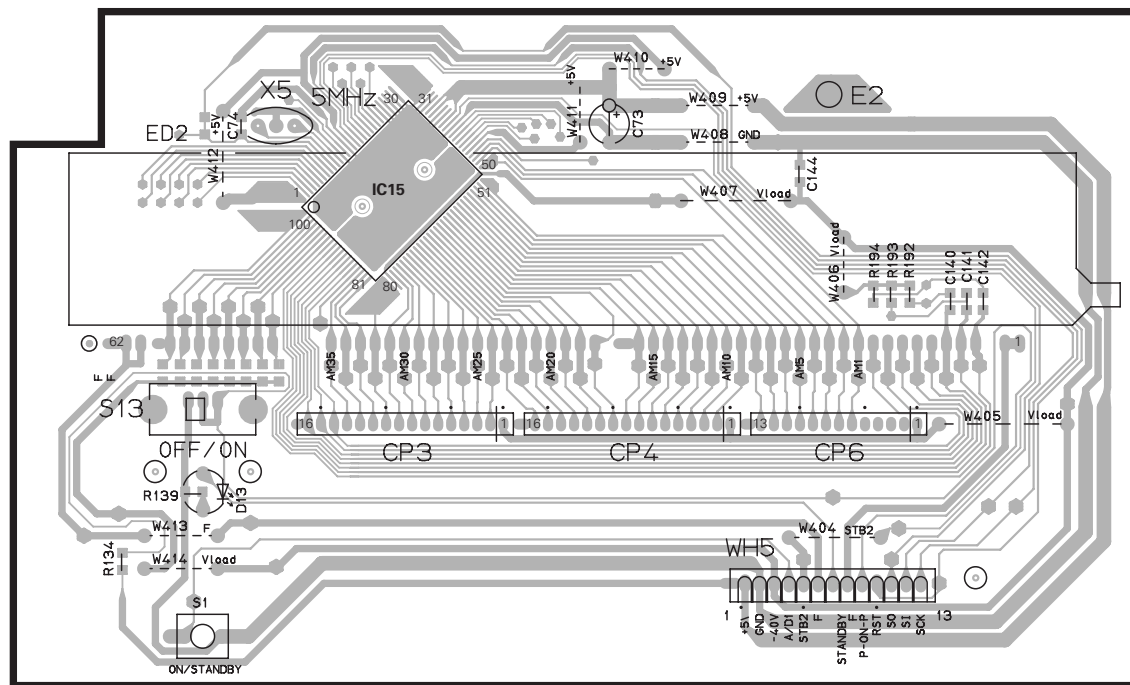

X32 C/8

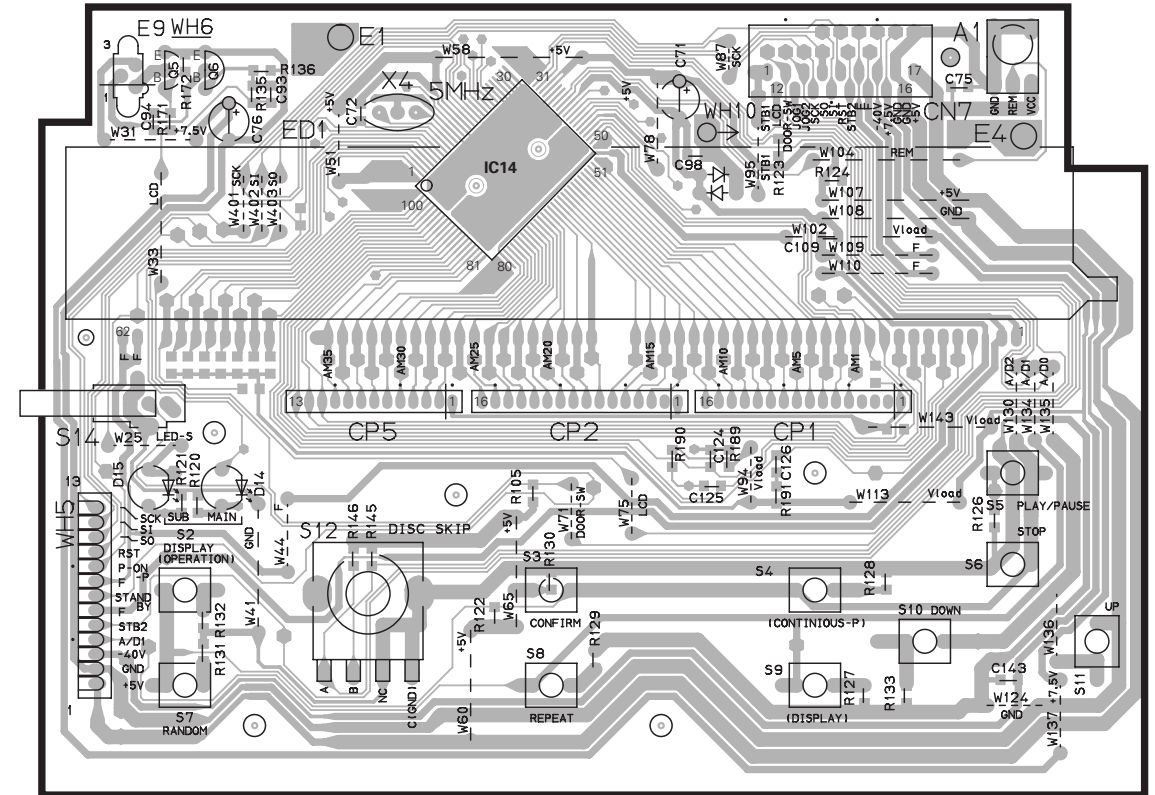

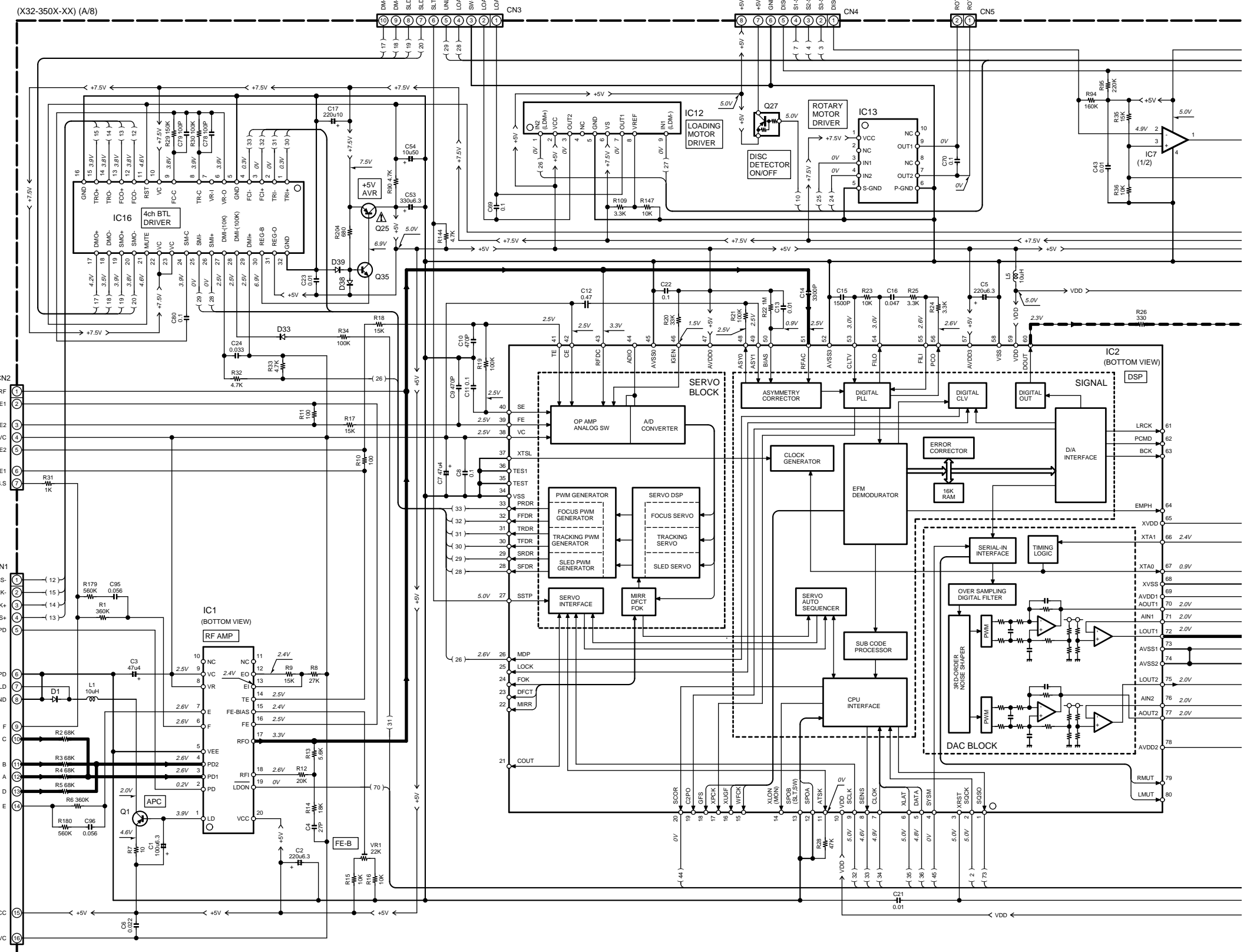
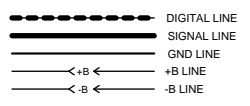
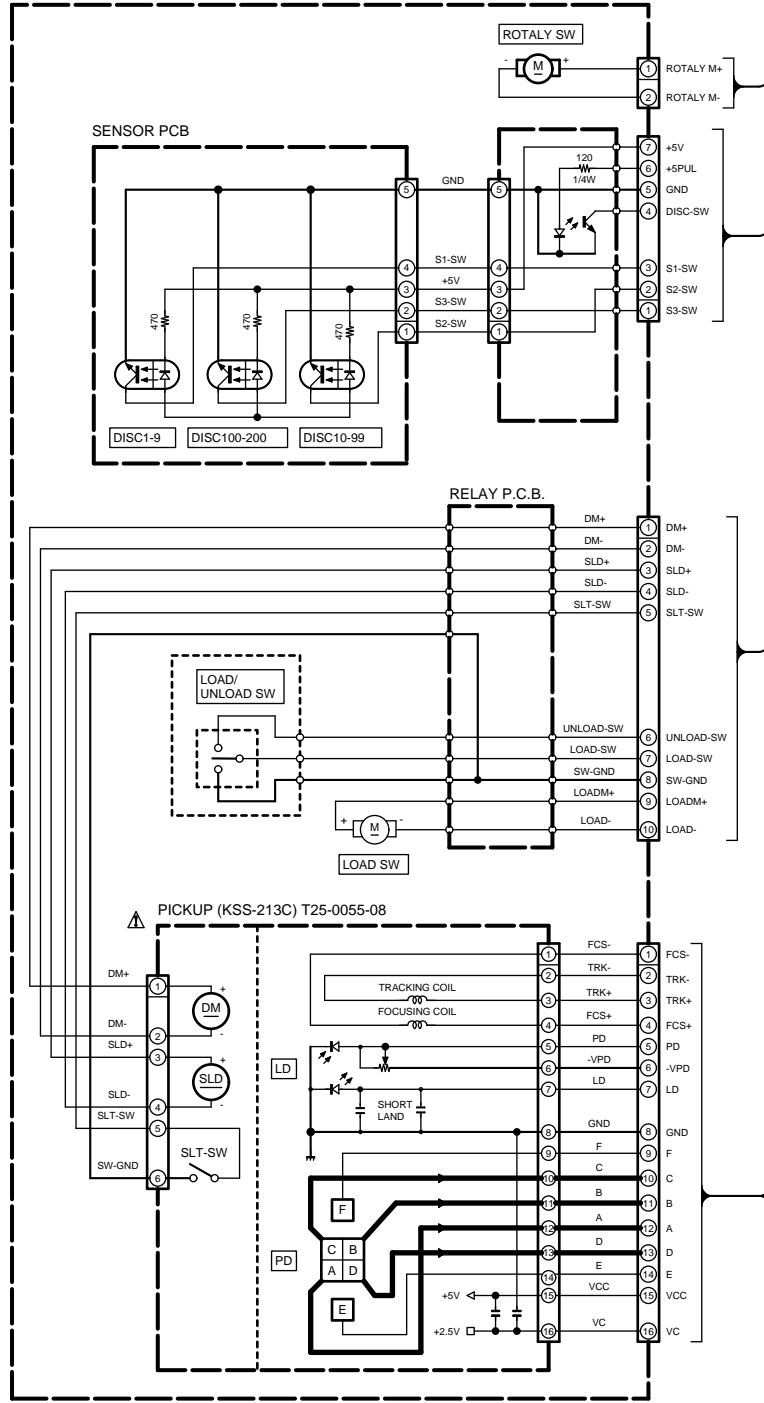

CD-2260M (X32-3500-10)

DESTINATION	COUNTRY	ABB.	UNIT No.	CN15	R104
U.S.A.	K		0-10	NO	YES
CANADA	P				

CD-2280M (X32-3500-11)

DESTINATION	COUNTRY	ABB.	UNIT No.	CN15	R104
U.S.A.	K		0-11	YES	NO
CANADA	P				

DPF-J7010 (X32-3502-71)

DESTINATION	COUNTRY	ABB.	UNIT No.	CN15	R104
AUSTRALIA	X		2-71	NO	YES

DPF-J9010 (X32-3502-72)

DESTINATION	COUNTRY	ABB.	UNIT No.	CN15	R104
U.K.	T		2-72	YES	NO
EUROPE	E				

IC1	: CXA1571M
IC2	: CXD2587Q
IC7	: NJM2100M
IC8	: uPD784215GF509
IC9	: 5M51008BFP70LL or 628128BLFP7SL
IC10	: uPD17215GT-737
IC11	: TC74HC00AF
IC12	: TA8409S
IC13	: LB1930M
IC16	: BA5979S

Q1	: 2SA954(L,K)
Q23	: UN5212 or DTC124EUA
Q24	: UN5112 or DTA124EUA
Q25	: 2SB1640 or 2SB1417(F)
Q26	: 2SC2003(L,K)
Q27	: UN4119 or DTA113ZSA
Q35	: 2SC2458(Y,GR) or 2SC3311A(Q,R)

D1-5,30-33,38 : HSS104 or 1SS133  
D39 : HZS5.1N(B2) or RDS.1ES(B2)

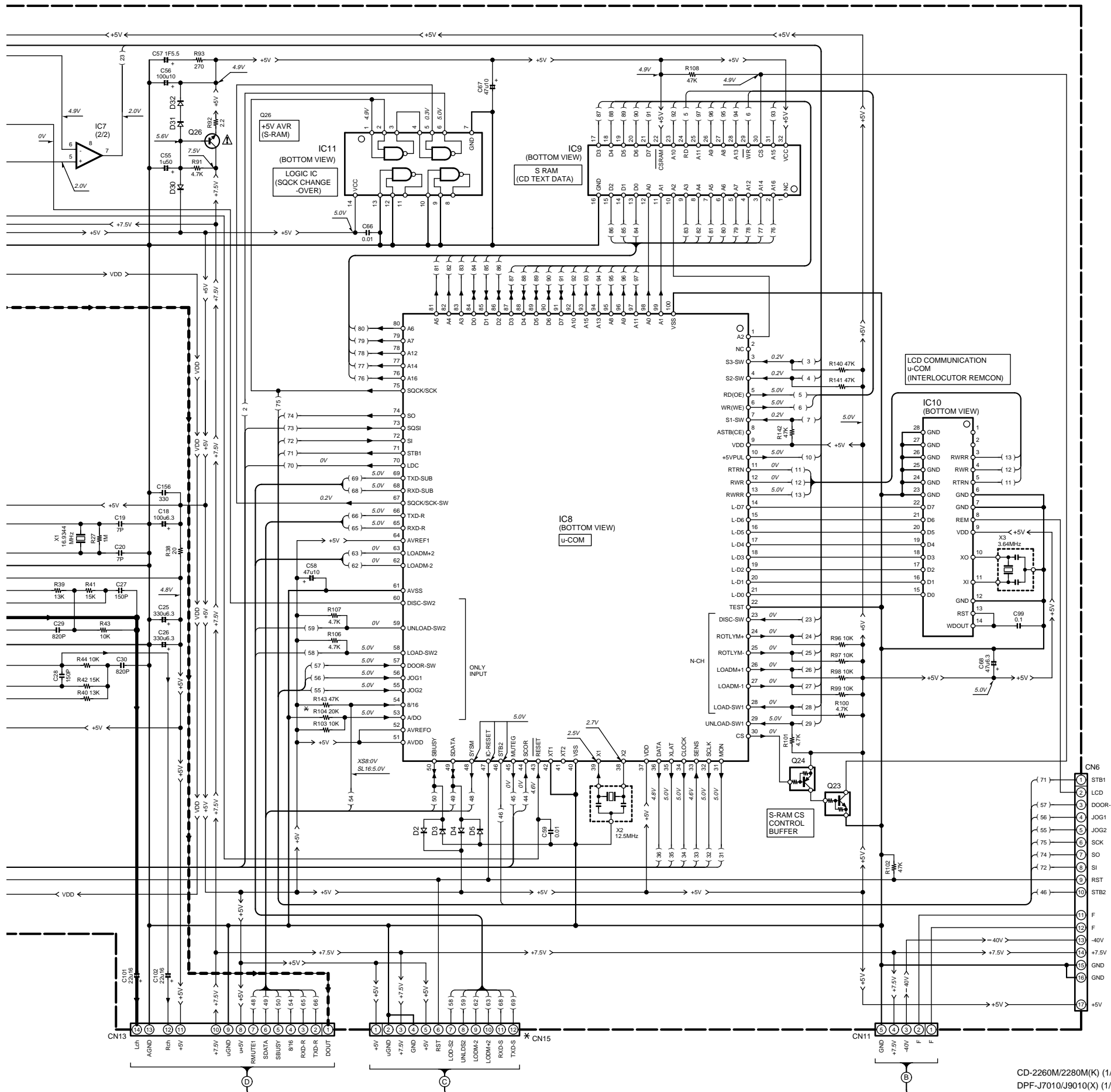

2SA954  
2SC2003  
2SC3246  
2SC3940A

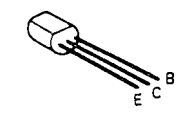

DTA113ZSA  
DTC124ESA  
2SA1048  
2SC2458

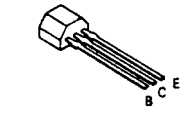

UN4212  
UN4219  
2SA1309A  
2SC3311A

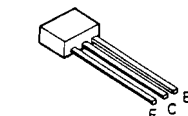

NJM2115M

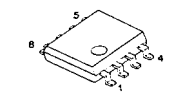

2SK246

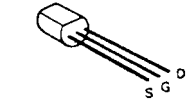

CAUTION: For continued safety, replace safety critical components only with manufacturer's recommended parts (refer to parts list).  $\Delta$  indicates safety critical components. For continued protection against risk of fire, replace only with same type and rating fuse(s). To reduce the risk of electric shock, leakage-current or resistance measurements shall be carried out (exposed parts are acceptably insulated from the supply circuit) before the appliance is returned to the customer.

TC74HC00AF

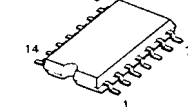

CXA1571M

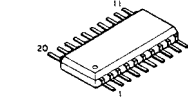

LB1930M

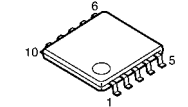

BA5979S

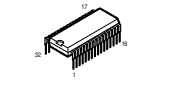

The DC voltage is an actual reading measured with a high impedance type voltmeter with no signal input. The measurement value may vary depending on the measuring instruments used or on the product.

TA8409S

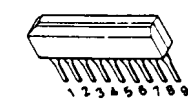

CXD2587Q

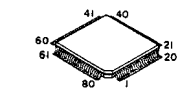

628128BLFP7SL

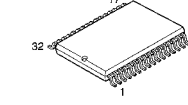

UN5212

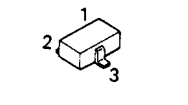

CD-2260M/2280M(K) (1/3)  
DPF-J7010/J9010(X) (1/3)

Y22-7390-10

CD-2260M/2280M/DPF-J7010/J9010

KENWOOD

X32-A/B  
-CN11  
1/3  
B  
X32-A/B  
-CN15  
1/3  
C

MECHA. ASSY  
(D40-1515-05)

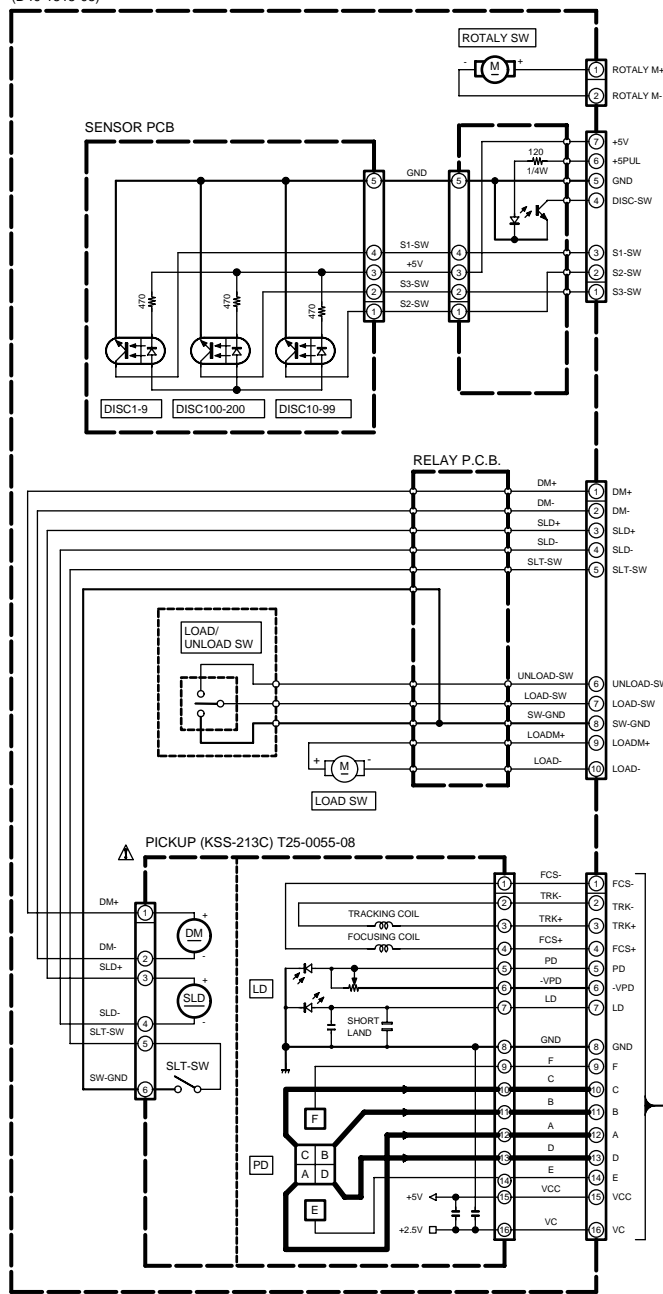

--- DIGITAL LINE  
--- SIGNAL LINE  
--- GND LINE  
--- +B LINE

X32-A/B  
-CN13  
1/3  
D

(X25-6060-10) : CD-2280M, DPF-J9010 ONLY

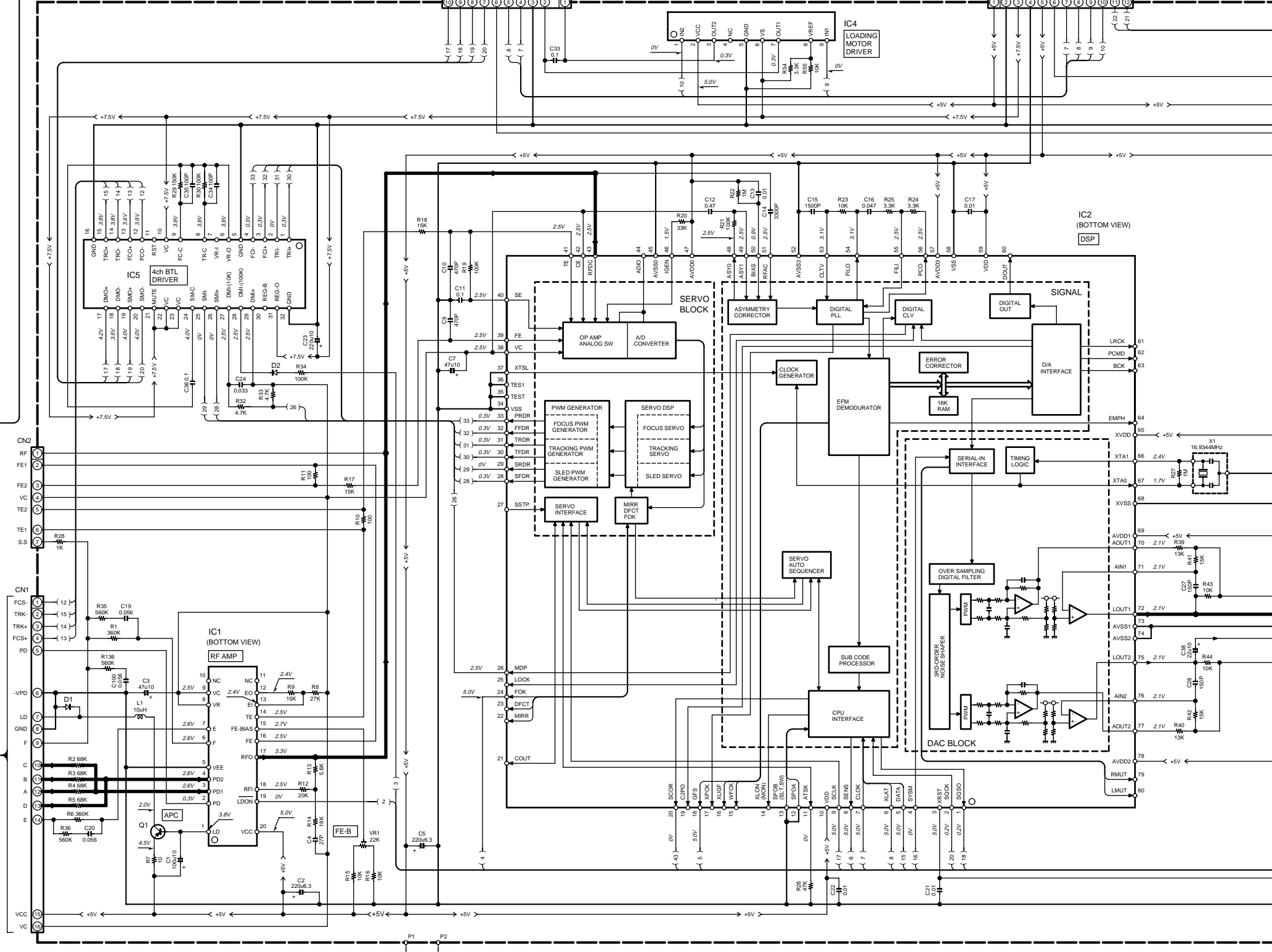

(X32-) (B/B)  
Q7 : UN4219 or DTC113ZSA  
Q8-10,33,34 : UN4212 or DTC124ESA  
Q11-14,30 : 2SA1309A(Q,R) or 2SA1048(Y,GR)  
Q15-18 : 2SD1450(S,T)  
Q29 : 2SC3311A(Q,R) or 2SC2458(Y,GR)  
Q31,32 : 2SA954(L,K)  
  
IC3,4,19,20 : NJM2100M  
IC5,6 : NJM2115M  
  
D6-11,34,35 : HSS104 or 1SS133



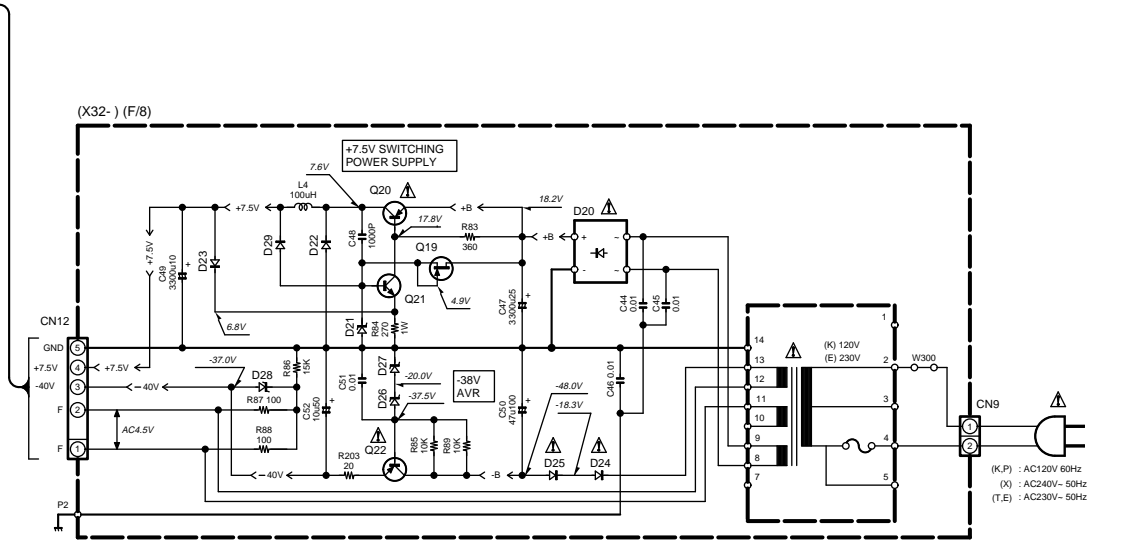
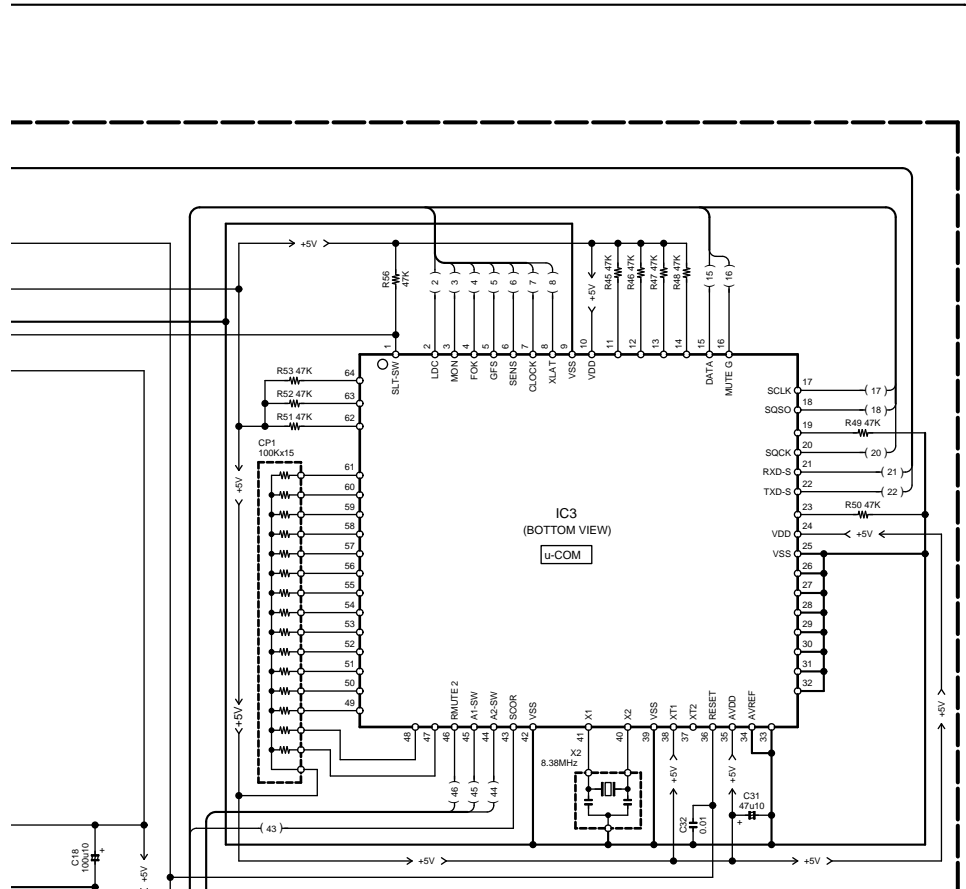

(X25-6060-10)

IC1 : CXA1571M  
 IC2 : CXD2587Q  
 IC3 : uPD780023GC501  
 IC4 : TA8409S  
 IC5 : BA5979S

Q1 : 2SA954(L,K)  
 D1,2 : HSS104 or 1S5133

(X32-) (F/8)

Q19 : 2SK246(Y)  
 Q20 : 2SB1143(S,T)  
 Q21 : 2SC3940A(Q,R)  
 Q22 : 2SA954(L,K)

D20 : D35BA20F03 or RBV-402,FA  
 D21 : RD7.5J(S,B2) or HZS7.5S(B2)  
 D22 : DLM10C  
 D23 : HSS104 or 1S5133  
 D24,25 : S5688B or 1SR139-400  
 D26 : RD16ES(B2) or HZS16N(B2)  
 D27 : RD20ES(B) or HZS20N(B)  
 D28 : RD11ES(B2) or HZS11N(B2)

DESTINATION	COUNTRY	ABB.	UNIT No.	ⓐ	ⓑ	ⓒ	ⓓ	E12	J1	W301-303
U.S.A.	K	X	0-10	NO	YES	NO	NO	NO	NO	YES
CANADA	P	P	0-10	NO	YES	NO	NO	NO	NO	YES

DESTINATION	COUNTRY	ABB.	UNIT No.	ⓐ	ⓑ	ⓒ	ⓓ	E12	J1	W301-303
U.S.A.	K	X	0-11	YES	NO	NO	NO	YES	NO	NO
CANADA	P	P	0-11	YES	NO	NO	NO	YES	NO	NO

DESTINATION	COUNTRY	ABB.	UNIT No.	ⓐ	ⓑ	ⓒ	ⓓ	E12	J1	W301-303
AUSTRALIA	X	T	2-71	NO	YES	YES	NO	YES	NO	YES

DESTINATION	COUNTRY	ABB.	UNIT No.	ⓐ	ⓑ	ⓒ	ⓓ	E12	J1	W301-303
AUSTRALIA	X	T	2-72	YES	NO	YES	YES	YES	NO	NO
U.S.A.	K	X	2-72	YES	NO	YES	YES	YES	NO	NO
EUROPE	E	T	2-72	YES	NO	YES	YES	YES	NO	NO

- 2SA954
- 2SC2003
- 2SC3246
- 2SC3940A
- DTA113ZSA
- DTC124ESA
- 2SA1048
- 2SC2458
- UN4212
- UN4219
- 2SA1309A
- 2SC3311A
- TA8409S
- NJM2115M
- UN5212
- 2SK246
- TC74HC00AF
- CXA1571M
- CXD2587Q
- LB1930M
- 628128BLFP7SL
- BA5979S

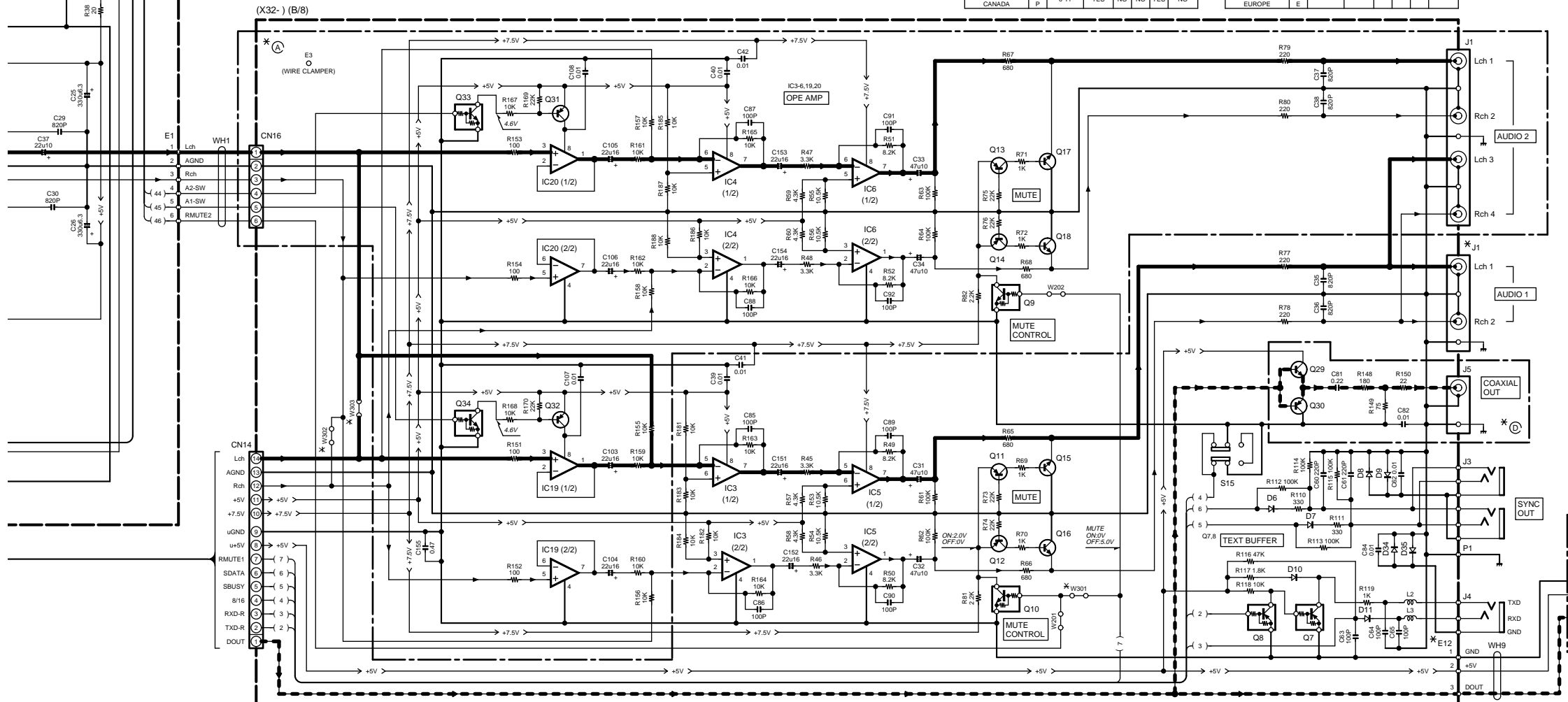

CAUTION: For continued safety, replace safety critical components only with manufacturer's recommended parts (refer to parts list). ⚠ indicates safety critical components. For continued protection against risk of fire, replace only with same type and rating fuse(s). To reduce the risk of electric shock, leakage-current or resistance measurements shall be carried out (exposed parts are acceptably insulated from the supply circuit) before the appliance is returned to the customer.

The DC voltage is an actual reading measured with a high impedance type voltmeter with no signal input. The measurement value may vary depending on the measuring instruments used or on the product.

CD-2260M/2280M(K) (2/3)  
 DPF-J7010/J9010(X) (2/3)

Y22-7390-10

CD-2260M/2280M/DPF-J7010/J9010

KENWOOD

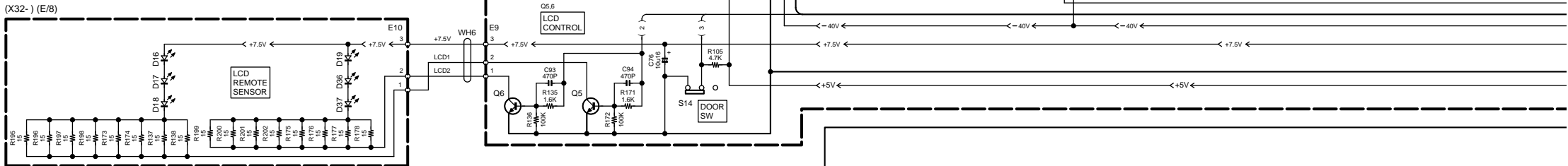
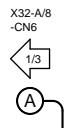
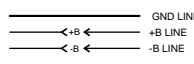
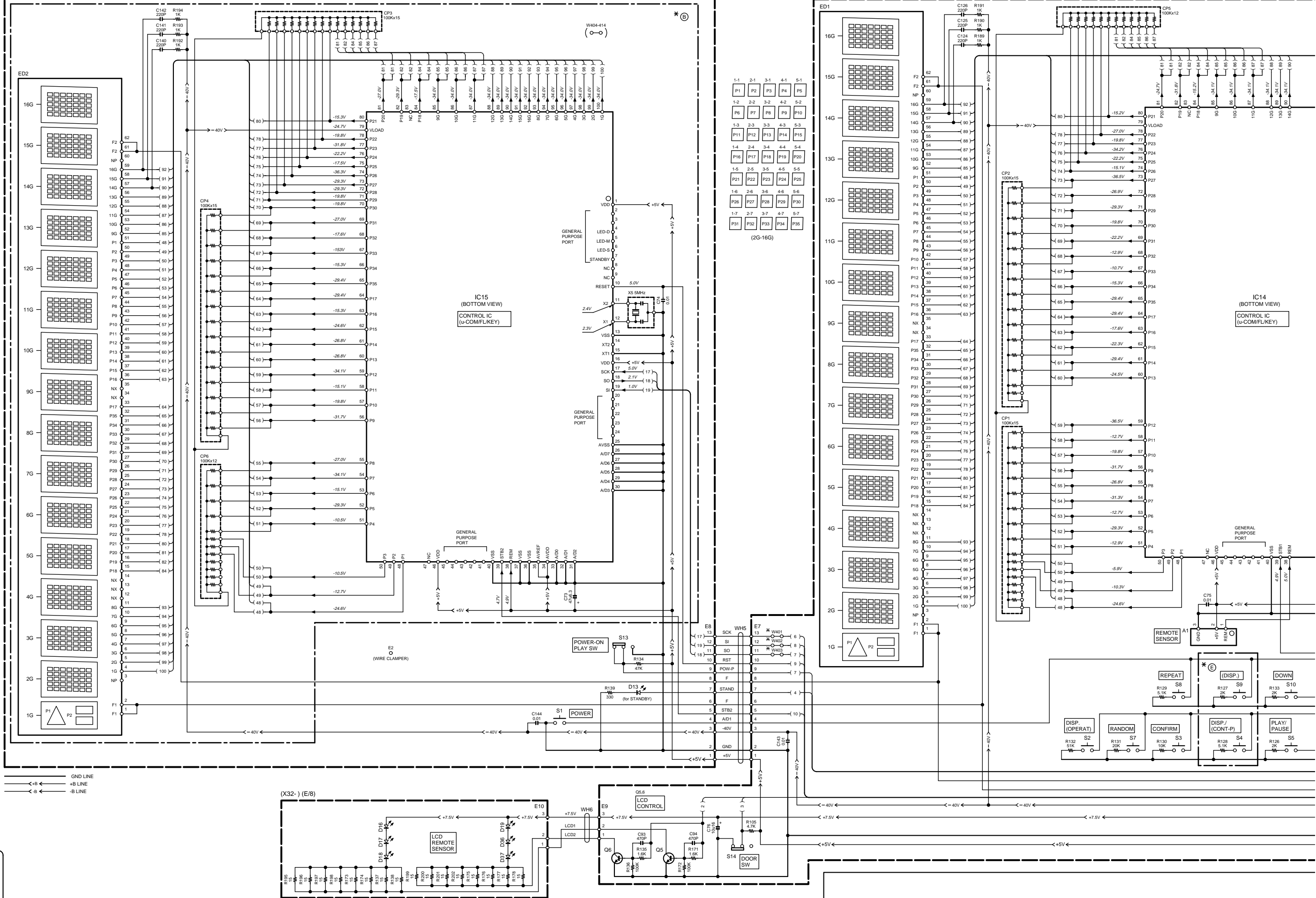

1  
2  
3  
4  
5  
6  
7

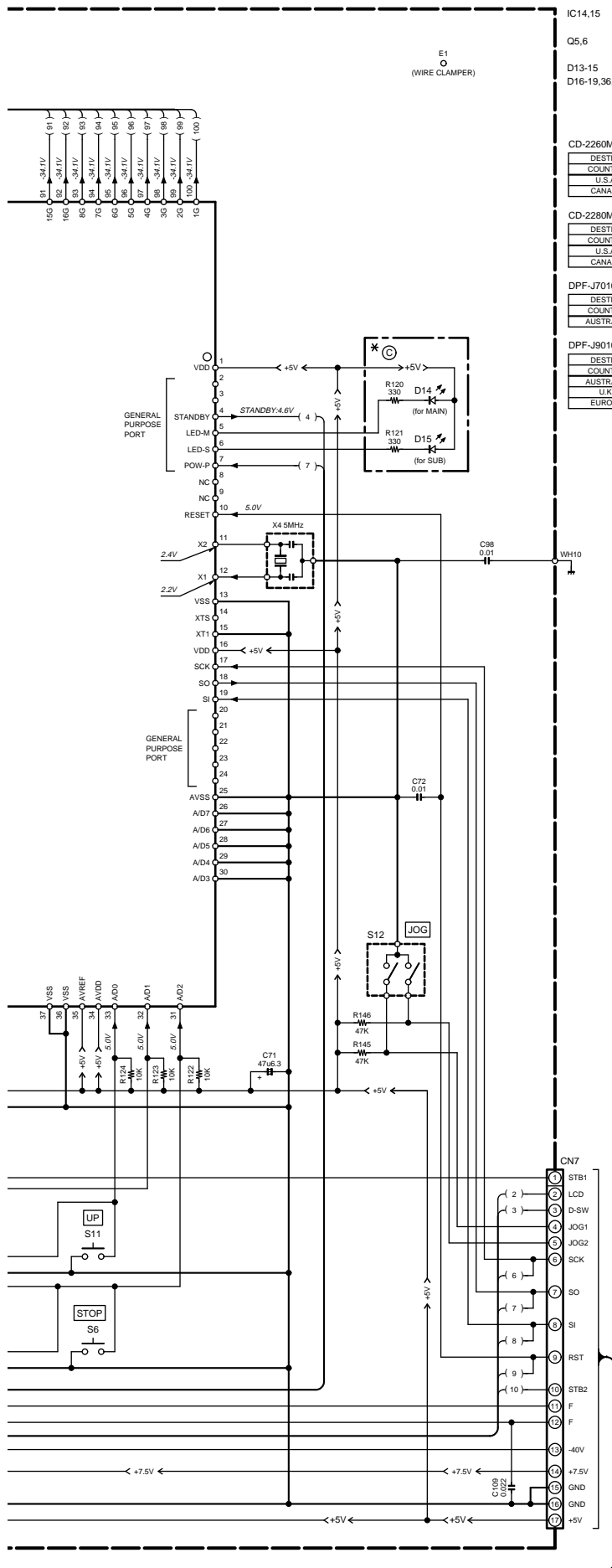

CD-2260M/2280M(K) (3/3)  
DPF-J7010/J9010(M) (3/3)

IC14,15 : uPD780204-034  
Q5,6 : 2SC3246(J,K)  
D13-15 : B30-2493-05  
D16-19,36,37 : B30-2532-05

CD-2260M (X32-3500-10)

DESTINATION	ABB.	UNIT No.	Ⓢ	Ⓢ	Ⓢ	W401-403
U.S.A.	K	0-10	NO	NO	NO	
CANADA	P					

CD-2280M (X32-3500-11)

DESTINATION	ABB.	UNIT No.	Ⓢ	Ⓢ	Ⓢ	W401-403
U.S.A.	K	0-11	YES	YES	YES	
CANADA	P					

DPF-J7010 (X32-3502-71)

DESTINATION	ABB.	UNIT No.	Ⓢ	Ⓢ	Ⓢ	W401-403
AUSTRALIA	X	2-71	NO	NO	NO	
U.K.	T					
EUROPE	E					

DPF-J9010 (X32-3502-72)

DESTINATION	ABB.	UNIT No.	Ⓢ	Ⓢ	Ⓢ	W401-403
AUSTRALIA	X	2-72	YES	YES	YES	
U.K.	T					
EUROPE	E					

UN4212  
UN4219  
2SA1309A  
2SC3311A

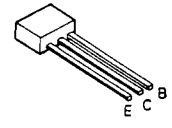

628128BLFP7SL

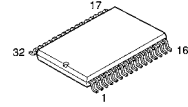

LB1930M

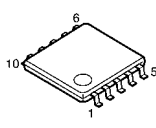

2SK246

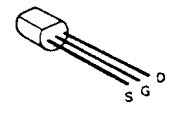

TA8409S

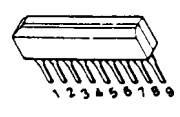

2SA954  
2SC2003  
2SC3246  
2SC3940A

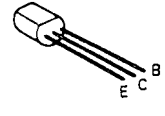

CXA1571M

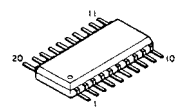

TC74HC00AF

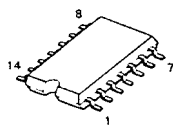

UN5212

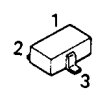

BA5979S

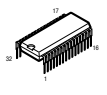

DTA113ZSA  
DTC124ESA  
2SA1048  
2SC2458

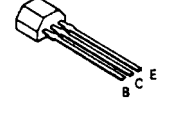

NJM2115M

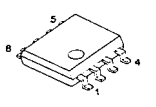

CXD2587Q

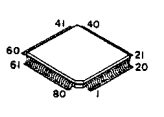

CAUTION: For continued safety, replace safety critical components only with manufacturer's recommended parts (refer to parts list). ⚠ indicates safety critical components. For continued protection against risk of fire, replace only with same type and rating fuse(s). To reduce the risk of electric shock, leakage-current or resistance measurements shall be carried out (exposed parts are acceptably insulated from the supply circuit) before the appliance is returned to the customer.

The DC voltage is an actual reading measured with a high impedance type voltmeter with no signal input. The measurement value may vary depending on the measuring instruments used or on the product.

# CD-2260M/2280M/DPF-J7010/J9010

## EXPLODED VIEW (MECHANISM)

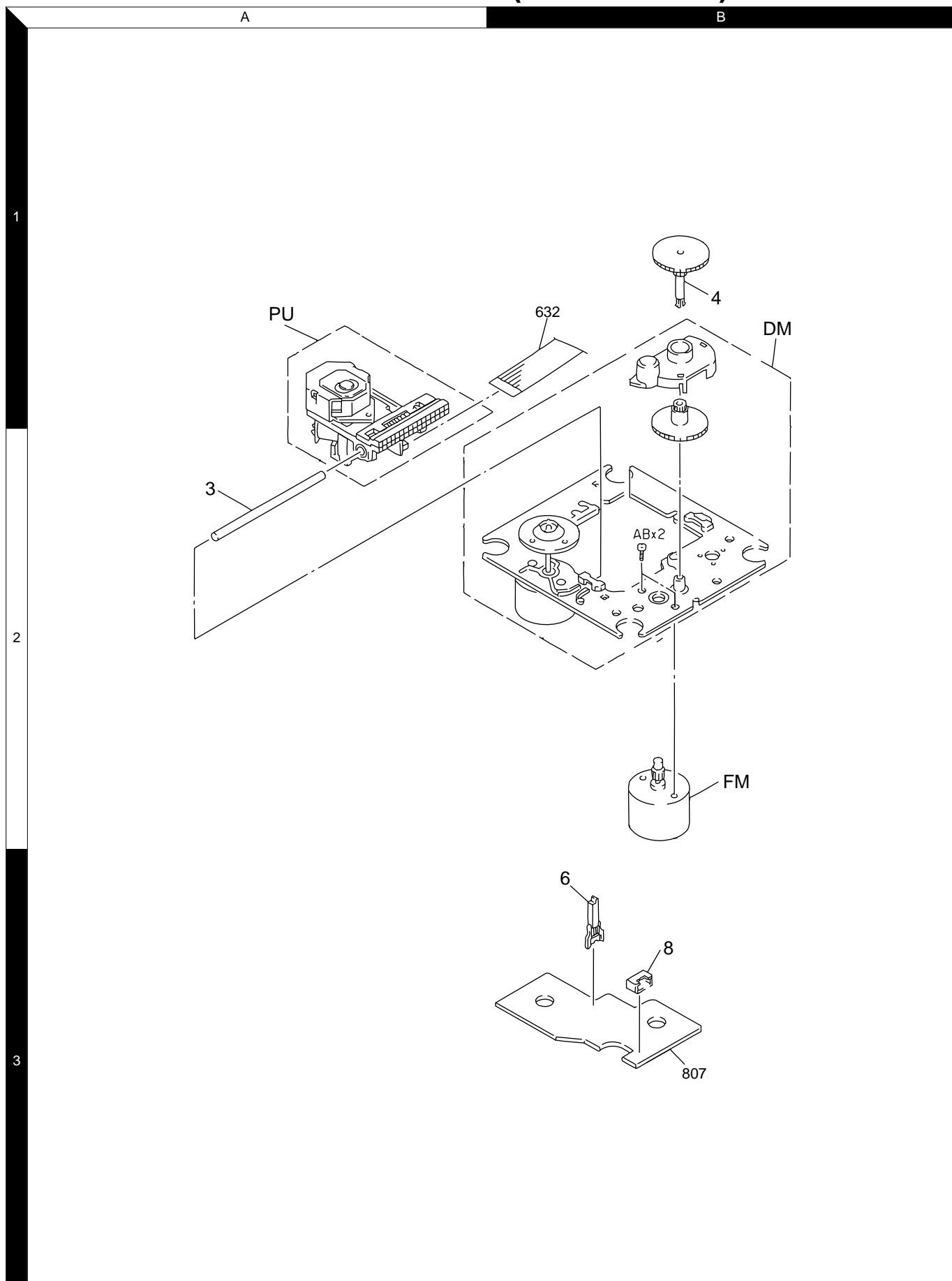

The left screen parts and the right are one and the same if no ref number.

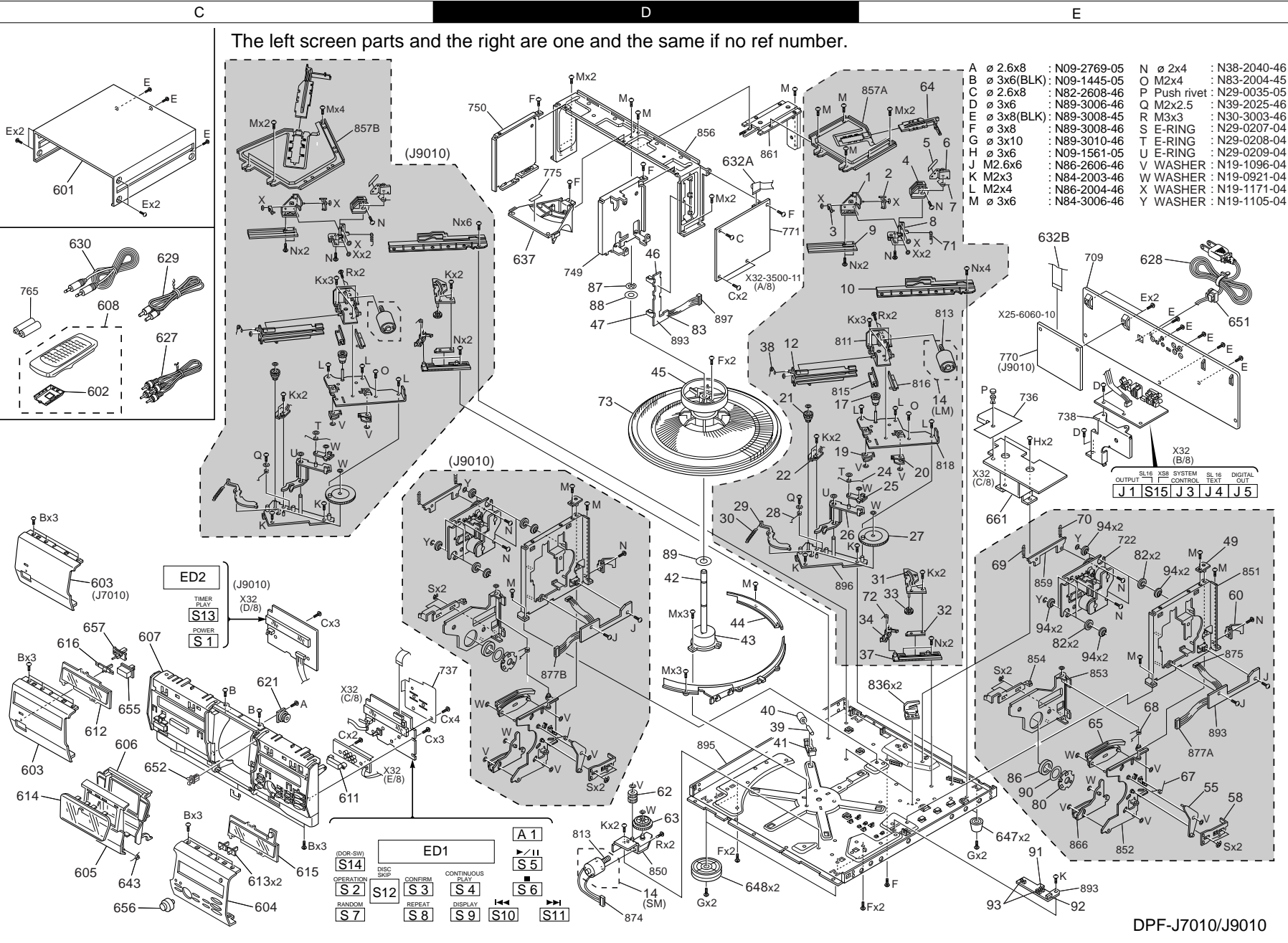

A	∅ 2.6x8	: N09-2769-05	N	∅ 2x4	: N38-2040-46
B	∅ 3x6(BLK)	: N09-1445-05	O	M2x4	: N83-2004-45
C	∅ 2.6x8	: N82-2608-46	P	Push rivet	: N29-0035-05
D	∅ 3x6	: N89-3006-46	Q	M2x2.5	: N39-2025-46
E	∅ 3x8(BLK)	: N89-3008-45	R	M3x3	: N30-3003-46
F	∅ 3x8	: N89-3008-46	S	E-RING	: N29-0207-04
G	∅ 3x10	: N89-3010-46	T	E-RING	: N29-0208-04
H	∅ 3x6	: N09-1561-05	U	E-RING	: N29-0209-04
J	M2.6x6	: N86-2606-46	V	WASHER	: N19-1096-04
K	M2x3	: N84-2003-46	W	WASHER	: N19-0921-04
L	M2x4	: N86-2004-46	X	WASHER	: N19-1171-04
M	∅ 3x6	: N84-3006-46	Y	WASHER	: N19-1105-04

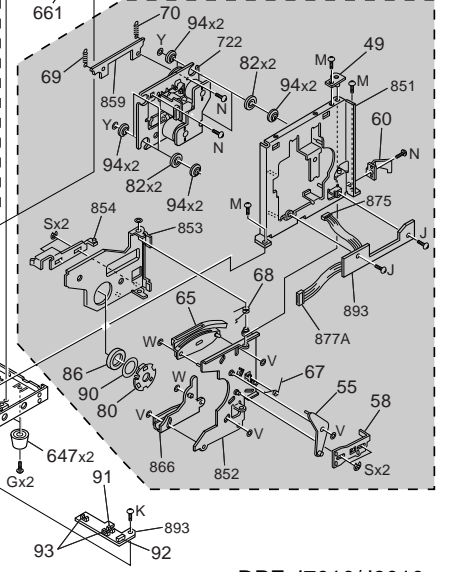
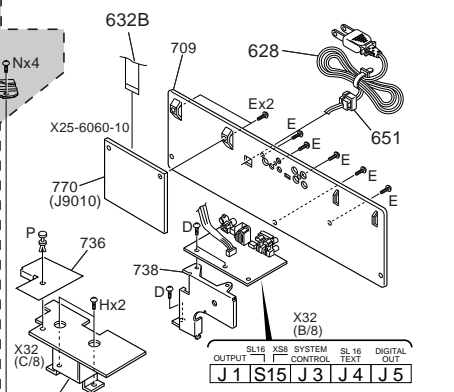

DPF-J7010/J9010

Parts with exploded numbers larger than 700 are not supplied.

\* New Parts  
Parts without **Parts No.** are not supplied.  
Les articles non mentionnés dans le **Parts No.** ne sont pas fournis.  
Teile ohne **Parts No.** werden nicht geliefert.



Ref. No	Add-ress	New Parts	Parts No.	Description	Desti-nation	Re-marks
<b>CD-2260M/DPF-J6010/CD-2280M/DPF-J9010</b>						
601	1C	*	A01-3536-08	METALLIC CABINET		
602	1C		A09-0374-08	BATTERY COVER		
603	2C	*	A21-1999-18	DRESSING PANEL B	K1P1	
603	2C	*	A21-3613-18	DRESSING PANEL B	K2P2	
603	2C	*	A21-3615-18	DRESSING PANEL B	X2	
603	2C	*	A21-3617-18	DRESSING PANEL B	X1T1E1	
604	2C	*	A21-2000-18	DRESSING PANEL A	K1P1X1	
604	2C	*	A21-2000-18	DRESSING PANEL A	T1E1	
604	2C	*	A21-3616-18	DRESSING PANEL A	K2P2X2	
605	2C	*	A29-0890-18	PANEL	K1P1X1	
605	2C	*	A29-0890-18	PANEL	T1E1	
605	2C	*	A29-0897-18	PANEL	K2P2X2	
606	2C	*	A46-0305-08	REAR COVER		
607	2C	*	A60-1255-08	PANEL	K1P1X1	
607	2C	*	A60-1255-08	PANEL	T1E1	
607	2C	*	A60-1259-08	PANEL	K2P2X2	
608	1C	*	A70-1174-08	REMOTE CONTROLLER (RC-P0506)	K1P1X1	
608	1C	*	A70-1174-08	REMOTE CONTROLLER (RC-P0506)	T1E1	
608	1C	*	A70-1175-08	REMOTE CONTROLLER (RC-P0306)	K2P2X2	
611	2C	*	B10-2405-08	FRONT GLASS REMOCON		
612	2C	*	B10-2456-08	FRONT GLASS B	K1P1X1	
612	2C	*	B10-2456-08	FRONT GLASS B	T1E1	
613	2C	*	B12-0327-08	INDICATOR MAIN/SUB	K1P1X1	
613	2C	*	B12-0327-08	INDICATOR MAIN/SUB	T1E1	
614	2C	*	B10-2395-08	FRONT GLASS		
615	2C	*	B10-2396-18	FRONT GLASS A		
616	2C	*	B12-0326-08	INDICATOR STANDBY		
-	-	-	B46-0096-53	WARRANTY CARD	X1X2	
-	-	-	B46-0197-00	QUESTIONNAIRE CARD	K1K2	
-	-	-	B46-0310-03	WARRANTY CARD	T1E1	
-	-	-	B46-0328-03	WARRANTY CARD	K1K2	
-	-	-	B46-0336-03	WARRANTY CARD	P1P2	
-	-	-	B58-0964-13	CAUTION CARD	K1K2	
-	-	-	B58-0965-13	CAUTION CARD	X1T1X2	
-	-	-	B58-0966-13	CAUTION CARD	E1	
-	-	-	B58-0967-03	CAUTION CARD	P1P2	
-	-	*	B60-3474-08	INSTRUCTION MANUAL(ENG)	K1P1X1	
-	-	*	B60-3474-08	INSTRUCTION MANUAL(ENG)	T1	
-	-	*	B60-3475-08	INSTRUCTION MANUAL(FRN)	P1E1	
-	-	*	B60-3479-08	INSTRUCTION MANUAL(ITL,SPN)	E1	
-	-	*	B60-3480-08	INSTRUCTION MANUAL(GRM,NTH)	E1	
-	-	*	B60-3517-08	INSTRUCTION MANUAL(ENG)	K2P2X2	
-	-	*	B60-3518-08	INSTRUCTION MANUAL(FRN)	P2	
621	2C		D39-0335-08	DAMPER		
627	1C		E30-0505-05	AUDIO CORD		
628	1E		E30-2787-05	AC POWER CORD	K1P1K2	
628	1E		E30-2787-05	AC POWER CORD	P2	
628	1E		E30-2788-05	AC POWER CORD	E1	
628	1E		E30-2790-05	AC POWER CORD	X1X2	
628	1E		E30-2791-05	AC POWER CORD	T1	
629	1C		E30-2816-05	CORD WITH PLUG,SYSTEM		
630	1C		E30-2861-05	CORD WITH PLUG,CD TEXT		

L: Scandinavia K: USA P: Canada R: Mexico C: China I: Malaysia  
Y: PX(Far East, Hawaii) T: Europe E: Europe G: Germany V: China (Shanghai) X1,P1: CD-2280M  
Y: AAFES(Europe) X: Australia Q: Russia H: Korea M: Other Areas X1,T1,E1: DPF-J9010  
K2,P2: CD-2260M X2: DPF-J7010

Δ indicates safety critical components.

\* New Parts  
Parts without **Parts No.** are not supplied.  
Les articles non mentionnés dans le **Parts No.** ne sont pas fournis.  
Teile ohne **Parts No.** werden nicht geliefert.



Ref. No	Add-ress	New Parts	Parts No.	Description	Desti-nation	Re-marks
632A	1D	*	E35-1948-08	FLAT CABLE 16P,MAIN-PICK		
632B	1E	*	E35-1949-08	FLAT CABLE 16P,SUB-PICK	K1P1X1	
632B	1E	*	E35-1949-08	FLAT CABLE 16P,SUB-PICK	T1E1	
637	1D		F07-1613-08	COVER PANEL-DISC		
643	2C		G01-4026-18	TORSION COIL SPRING		
-	-	-	H10-7397-08	POLYSTYRENE FOAMED FIXTURE		
-	-	-	H10-7398-08	POLYSTYRENE FOAMED FIXTURE		
-	-	-	H12-2401-08	PACKING FIXTURE		
-	-	-	H21-0359-08	PROTECTION SHEET		
-	-	-	H25-0232-04	PROTECTION BAG (235X350X0.03)	E1K2P2	
-	-	-	H25-0232-04	PROTECTION BAG (235X350X0.03)	K1P1X1	
-	-	-	H25-0232-04	PROTECTION BAG (235X350X0.03)	X2	
-	-	-	H25-0651-04	PROTECTION BAG	T1	
-	-	-	H25-0692-04	PROTECTION BAG		
-	-	*	H50-2612-08	ITEM CARTON CASE	K1P1	
-	-	*	H50-2613-08	ITEM CARTON CASE	X1T1E1	
-	-	*	H50-2619-08	ITEM CARTON CASE	K2P2	
-	-	*	H50-2757-08	ITEM CARTON CASE	X2	
647	2E		J02-1067-05	FOOT(REAR)		
648	2D		J02-1404-13	FOOT(FRONT) (D=46,H=18.5,T)		
651	1E		J42-0083-05	POWER CORD BUSHING		
652	2C		J52-0039-05	PUSH LATCH		
-	-	-	J61-0098-05	WIRE BAND		
655	2C		K27-2248-04	KNOB (BUTTON) POWER	X1T1E1	
656	2C	*	K29-6803-08	KNOB JOG		
657	2C	*	K29-6884-08	KNOB REC TIMER		
661	2E	*	L07-2446-08	POWER TRANSFORMER	K1P1	
661	2E	*	L07-2448-08	POWER TRANSFORMER	X1T1E1	
661	2E	*	L07-2449-08	POWER TRANSFORMER	K2P2	
661	2E	*	L07-2451-08	POWER TRANSFORMER	X2	
<b>SUB CONTROL (X25-6060-10)</b>						
C1			CE04KW1A101M	ELECTRO 100UF	10WV	
C2			CE04KW0J221M	ELECTRO 220UF	6.3WV	
C3			CE04KW1A470M	ELECTRO 47UF	10WV	
C4			CC45FSL1H270J	CERAMIC 27PF	J	
C5			CE04KW0J221M	ELECTRO 220UF	6.3WV	
C7			CE04KW1A470M	ELECTRO 47UF	10WV	
C9 ,10			CK45FB1H471K	CERAMIC 470PF	K	
C11			CF92FV1H104J	MF-C 0.10UF	J	
C12			CF92FV1H474J	MF-C 0.47UF	J	
C13			CQ93FMG1H103J	MYLAR 0.010UF	J	
C14			CK45FB1H332K	CERAMIC 3300PF	K	
C15			CK45FB1H152K	CERAMIC 1500PF	K	
C16			CQ93FMG1H473J	MYLAR 0.047UF	J	
C17			CK45FF1H103Z	CERAMIC 0.010UF	Z	
C18			CE04KW1A101M	ELECTRO 100UF	10WV	
C19 ,20			CF92FV1H563J	MF-C 0.056UF	J	
C21 ,22			CK45FF1H103Z	CERAMIC 0.010UF	Z	
C23			CE04KW1A221M	ELECTRO 220UF	10WV	
C24			CQ93FMG1H333J	MYLAR 0.033UF	J	
C25 ,26			CE04KW0J331M	ELECTRO 330UF	6.3WV	
C27 ,28			CC45FSL1H151J	CERAMIC 150PF	J	

L: Scandinavia K: USA P: Canada R: Mexico C: China I: Malaysia  
Y: PX(Far East, Hawaii) T: Europe E: Europe G: Germany V: China (Shanghai) X1,P1: CD-2280M  
Y: AAFES(Europe) X: Australia Q: Russia H: Korea M: Other Areas X1,T1,E1: DPF-J9010  
K2,P2: CD-2260M X2: DPF-J7010

Δ indicates safety critical components.

\* New Parts  
 Parts without **Parts No.** are not supplied.  
 Les articles non mentionnés dans le **Parts No.** ne sont pas fournis.  
 Teile ohne **Parts No.** werden nicht geliefert.

3

Ref. No	Add-ress	New Parts	Parts No.	Description	Desti-nation	Re-marks
C29 ,30			CQ93FMG1H821J	MYLAR 820PF J		
C31			CE04KW1A470M	ELECTRO 47UF 10WV		
C32			CK45FF1H103Z	CERAMIC 0.010UF Z		
C33			CF92FV1H104J	MF-C 0.10UF J		
C34 ,35			CC45FSL1H101J	CERAMIC 100PF J		
C36			CF92FV1H104J	MF-C 0.10UF J		
C37 ,38			CE04KW1A220M	ELECTRO 22UF 10WV		
CN1			E40-4997-05	FLAT CABLE CONNECTOR		
CN2			E40-4979-05	PIN ASSY		
CN3			E40-3268-05	PIN ASSY		
CN4			E40-3256-05	PIN ASSY		
P1 ,2			J21-5845-04	MOUNTING HARDWARE		
L1			L40-1001-17	SMALL FIXED INDUCTOR(10UH,K)		
X1			L78-0299-05	RESONATOR (16.93M)		
X2			L78-0605-05	RESONATOR (8.38MHZ)		
CP1			R90-0875-05	MULTI-COMP 100KX15		
VR1			R12-3101-05	TRIMMING POT.		
D1 ,2			HSS104	DIODE		
D1 ,2			1SS133	DIODE		
IC1			CXA1571M	ANALOGUE IC		
IC2			CXD2587Q	MOS-IC		
IC3			UPD780023GC501	MI-COM IC		
IC4			TA8409S	MOS-IC		
IC5			BA5979S	ANALOGUE IC		
Q1			2SA954(L,K)	TRANSISTOR		
<b>MAIN CONTROL (X32-3500-10)</b>						
D13			B30-2493-05	LED(REDF)		
D14 ,15			B30-2493-05	LED(REDF)	K1P1X1	
D14 ,15			B30-2493-05	LED(REDF)	T1E1	
D16 -19			B30-2532-05	LED(INFRARED)		
D36 ,37			B30-2532-05	LED(INFRARED)		
C1			C90-3214-05	ELECTRO 100UF 6.3WV		
C2			C90-3215-05	ELECTRO 220UF 6.3WV		
C3			C90-3203-05	ELECTRO 47UF 4WV		
C4			CC73FSL1H270J	CHIP C 27PF J		
C5			CE04KW0J221M	ELECTRO 220UF 6.3WV		
C6			CK73FB1H223K	CHIP C 0.022UF K		
C7			C90-3203-05	ELECTRO 47UF 4WV		
C8			CK73FB1E104K	CHIP C 0.10UF K		
C9 ,10			CC73FSL1H471J	CHIP C 470PF J		
C11			CK73FB1E104K	CHIP C 0.10UF K		
C12			CK73FB1C474K	CHIP C 0.47UF K		
C13			CK73FB1H103K	CHIP C 0.010UF K		
C14			CK73FB1H332K	CHIP C 3300PF K		
C15			CK73FB1H152K	CHIP C 1500PF K		
C16			CK73FB1H473K	CHIP C 0.047UF K		
C17			C90-3223-05	ELECTRO 220UF 10WV		
C18			C90-3214-05	ELECTRO 100UF 6.3WV		
C19 ,20			CC73FSL1H070D	CHIP C 7.0PF D		
C21			CK73FB1H103K	CHIP C 0.010UF K		
C22			CK73FB1E104K	CHIP C 0.10UF K		
C23			CK73FB1H103K	CHIP C 0.010UF K		

L : Scandinavia K : USA P : Canada R : Mexico C : China I : Malaysia  
 Y : PX(Far East, Hawaii) T : Europe E : Europe G : Germany V : China (Shanghai) K1,P1 : CD-2280M  
 Y : AAFES(Europe) X : Australia Q : Russia H : Korea M : Other Areas X1,T1,E1 : DPF-J9010  
 K2,P2 : CD-2260M X2 : DPF-J7010  
 Δ indicates safety critical components.

\* New Parts  
 Parts without **Parts No.** are not supplied.  
 Les articles non mentionnés dans le **Parts No.** ne sont pas fournis.  
 Teile ohne **Parts No.** werden nicht geliefert.

4

Ref. No	Add-ress	New Parts	Parts No.	Description	Desti-nation	Re-marks
C24			CK73FB1H333K	CHIP C 0.033UF K		
C25 ,26			CE04KW0J331M	ELECTRO 330UF 6.3WV		
C27 ,28			CC73FSL1H151J	CHIP C 150PF J		
C29 ,30			CC73FSL1H821J	CHIP C 820PF J		
C31 ,32			CE04KW1A470M	ELECTRO 47UF 10WV		
C33 ,34			CE04KW1A470M	ELECTRO 47UF 10WV	K1P1X1	
C33 ,34			CE04KW1A470M	ELECTRO 47UF 10WV	T1E1	
C35 ,36			CC73FSL1H821J	CHIP C 820PF J		
C37 ,38			CC73FSL1H821J	CHIP C 820PF J	K1P1X1	
C37 ,38			CC73FSL1H821J	CHIP C 820PF J	T1E1	
C39			CK73FB1H103K	CHIP C 0.010UF K		
C40			CK73FB1H103K	CHIP C 0.010UF K	K1P1X1	
C40			CK73FB1H103K	CHIP C 0.010UF K	T1E1	
C41			CK73FB1H103K	CHIP C 0.010UF K		
C42			CK73FB1H103K	CHIP C 0.010UF K	K1P1X1	
C42			CK73FB1H103K	CHIP C 0.010UF K	T1E1	
C43			CK73FB1H103K	CHIP C 0.010UF K		
C44 -46			CK45FF1H103Z	CERAMIC 0.010UF Z		
C47			CE04KW1E332M	ELECTRO 3300UF 25WV		
C48			CK73FB1H102K	CHIP C 1000PF K		
C49			CE04KW1A332M	ELECTRO 3300UF 10WV		
C50			CE04KW2A470M	ELECTRO 47UF 100WV		
C51			CK73FB1H103K	CHIP C 0.010UF K		
C52			CE04KW1H100M	ELECTRO 10UF 50WV		
C53			CE04KW0J331M	ELECTRO 330UF 6.3WV		
C54			CE04KW1H100M	ELECTRO 10UF 50WV		
C55			CE04KW1H010M	ELECTRO 1.0UF 50WV		
C56			CE04KW1A101M	ELECTRO 100UF 10WV		
C57			C90-3542-05	SUPER-C 1.0F 5.5WV		
C58			CE04KW1A470M	ELECTRO 47UF 10WV		
C59			CK73FB1H103K	CHIP C 0.010UF K		
C60 ,61			CC73FSL1H221J	CHIP C 220PF J		
C62			CK73FB1H103K	CHIP C 0.010UF K		
C63 -65			CC73FSL1H101J	CHIP C 100PF J		
C66			CK73FB1H103K	CHIP C 0.010UF K		
C67			CE04KW1A470M	ELECTRO 47UF 10WV		
C68			C90-3212-05	ELECTRO 47UF 6.3WV		
C69 ,70			CK73FB1E104K	CHIP C 0.10UF K		
C71			C90-3212-05	ELECTRO 47UF 6.3WV		
C72			CK73FB1H103K	CHIP C 0.010UF K		
C73			C90-3212-05	ELECTRO 47UF 6.3WV	K1P1X1	
C73			C90-3212-05	ELECTRO 47UF 6.3WV	T1E1	
C74			CK73FB1H103K	CHIP C 0.010UF K	K1P1X1	
C74			CK73FB1H103K	CHIP C 0.010UF K	T1E1	
C75			CK73FB1H103K	CHIP C 0.010UF K		
C76			C90-3225-05	ELECTRO 10UF 16WV		
C78 ,79			CC73FSL1H101J	CHIP C 100PF J		
C80			CK73FB1E104K	CHIP C 0.10UF K		
C81			CK73FB1C224K	CHIP C 0.22UF K	K1P1K2	
C81			CK73FB1C224K	CHIP C 0.22UF K	P2	
C82			CK73FF1C105Z	CHIP C 1.0UF Z	K1P1K2	
C82			CK73FF1C105Z	CHIP C 1.0UF Z	P2	
C83			CK73FB1E104K	CHIP C 0.10UF K	X1T1E1	
C83			CK73FB1E104K	CHIP C 0.10UF K	X2	
C84			CK73FB1H103K	CHIP C 0.010UF K		

L : Scandinavia K : USA P : Canada R : Mexico C : China I : Malaysia  
 Y : PX(Far East, Hawaii) T : Europe E : Europe G : Germany V : China (Shanghai) K1,P1 : CD-2280M  
 Y : AAFES(Europe) X : Australia Q : Russia H : Korea M : Other Areas X1,T1,E1 : DPF-J9010  
 K2,P2 : CD-2260M X2 : DPF-J7010  
 Δ indicates safety critical components.

PARTS LIST

CD-2260M/2280M/DPF-J7010/J9010

\* New Parts  
Parts without **Parts No.** are not supplied.  
Les articles non mentionnés dans le **Parts No.** ne sont pas fournis.  
Teile ohne **Parts No.** werden nicht geliefert.

5

Ref. No	Add-ress	New Parts	Parts No.	Description	Desti-nation	Re-marks
C85 ,86			CC73FSL1H101J	CHIP C 100PF J		
C87 ,88			CC73FSL1H101J	CHIP C 100PF J	K1P1X1	
C87 ,88			CC73FSL1H101J	CHIP C 100PF J	T1E1	
C89 ,90			CC73FSL1H101J	CHIP C 100PF J		
C91 ,92			CC73FSL1H101J	CHIP C 100PF J	K1P1X1	
C91 ,92			CC73FSL1H101J	CHIP C 100PF J	T1E1	
C93 ,94			CC73FSL1H471J	CHIP C 470PF J		
C95 ,96			CK73FB1H563K	CHIP C 0.056UF K		
C98			CK73FB1H103K	CHIP C 0.010UF K		
C99			CK73FB1E104K	CHIP C 0.10UF K		
C101,102			CE04KW1C220M	ELECTRO 22UF 16WV		
C103-106			CE04KW1C220M	ELECTRO 22UF 16WV	K1P1X1	
C103-106			CE04KW1C220M	ELECTRO 22UF 16WV	T1E1	
C107,108			CK73FB1H103K	CHIP C 0.010UF K	K1P1X1	
C107,108			CK73FB1H103K	CHIP C 0.010UF K	T1E1	
C109			CK73FB1H223K	CHIP C 0.022UF K		
C124-126			CC73FSL1H221J	CHIP C 220PF J		
C140-142			CC73FSL1H221J	CHIP C 220PF J	K1P1X1	
C140-142			CC73FSL1H221J	CHIP C 220PF J	T1E1	
C143			CK73FB1H103K	CHIP C 0.010UF K		
C144			CK73FB1H103K	CHIP C 0.010UF K	K1P1X1	
C144			CK73FB1H103K	CHIP C 0.010UF K	T1E1	
C151,152			CE04KW1C220M	ELECTRO 22UF 16WV		
C153,154			CE04KW1C220M	ELECTRO 22UF 16WV	K1P1X1	
C153,154			CE04KW1C220M	ELECTRO 22UF 16WV	T1E1	
C155			CK73FB1C474K	CHIP C 0.47UF K		
C156			C90-3216-05	ELECTRO 330UF 6.3WV		
CN1			E40-4997-05	FLAT CABLE CONNECTOR		
CN2			E40-4979-05	PIN ASSY		
CN3			E40-3268-05	PIN ASSY		
CN4			E40-3266-05	PIN ASSY		
CN5			E40-3260-05	PIN ASSY		
CN6 ,7			E40-4942-05	FLAT CABLE CONNECTOR		
CN9			E40-4245-05	PIN ASSY		
CN11,12			E40-3249-05	PIN ASSY		
CN13,14			E40-3258-05	PIN ASSY		
CN15			E40-3270-05	PIN ASSY	K1P1X1	
CN15			E40-3270-05	PIN ASSY	T1E1	
CN16			E40-4296-05	FLAT CABLE CONNECTOR	K1P1X1	
CN16			E40-4296-05	FLAT CABLE CONNECTOR	T1E1	
J1	1E		E63-0120-05	PHONO JACK OUTPUT	K1P1X1	
J1	1E		E63-0120-05	PHONO JACK OUTPUT	T1E1	
J1	1E		E63-0122-05	PHONO JACK OUTPUT	K2P2X2	
J3	1E		E11-0293-05	MINIATURE PHONE JACK(2P)SYSTEM		
J4	1E		E11-0360-05	MINIATURE PHONE JACK(BLK,2.5)		
J5	1E		E63-0199-05	PHONO JACK DIGITAL OUT	K1P1K2	
J5	1E		E63-0199-05	PHONO JACK DIGITAL OUT	P2	
-			J19-5789-04	HOLDER FL		
E1 -3			J11-0809-05	WIRE CLAMPER	K1P1X1	
E1 -3			J11-0809-05	WIRE CLAMPER	T1E1	
E1 ,2			J11-0809-05	WIRE CLAMPER	K2P2X2	
L1			L40-1001-17	SMALL FIXED INDUCTOR(10UH,K)		
L2 ,3			L79-1216-05	LINE FILTER		
L4			L33-0558-05	CHOKO COIL		

L : Scandinavia K : USA P : Canada R : Mexico C : China I : Malaysia  
Y : PX(Far East, Hawaii) T : Europe E : Europe G : Germany V : China (Shanghai) K1,P1 : CD-2280M  
Y : AAFES(Europe) X : Australia Q : Russia H : Korea M : Other Areas X1,T1,E1 : DPF-J9010  
K2,P2 : CD-2260M X2 : DPF-J7010  
⚠ indicates safety critical components.

\* New Parts  
Parts without **Parts No.** are not supplied.  
Les articles non mentionnés dans le **Parts No.** ne sont pas fournis.  
Teile ohne **Parts No.** werden nicht geliefert.

6

Ref. No	Add-ress	New Parts	Parts No.	Description	Desti-nation	Re-marks
L5			L40-1001-17	SMALL FIXED INDUCTOR(10UH,K)		
X1			L77-2226-05	CRYSTAL RESONATOR(16.9344MHZ)		
X2			L78-0615-05	RESONATOR (12.5MHZ)		
X3			L78-0674-05	RESONATOR		
X4			L78-0284-05	RESONATOR (5MHZ)		
X5			L78-0284-05	RESONATOR (5MHZ)	K1P1X1	
X5			L78-0284-05	RESONATOR (5MHZ)	T1E1	
CP1 ,2			R90-0875-05	MULTI-COMP 100KX15		
CP3 ,4			R90-0875-05	MULTI-COMP 100KX15	K1P1X1	
CP3 ,4			R90-0875-05	MULTI-COMP 100KX15	T1E1	
CP5			R90-0479-05	MULTI-COMP 100KX12		
CP6			R90-0479-05	MULTI-COMP 100KX12	K1P1X1	
CP6			R90-0479-05	MULTI-COMP 100KX12	T1E1	
R1			RK73FB2A364J	CHIP R 360K J 1/10W		
R2 -5			RK73FB2A683J	CHIP R 68K J 1/10W		
R6			RK73FB2A364J	CHIP R 360K J 1/10W		
R7			RK73FB2A100J	CHIP R 10 J 1/10W		
R8			RK73FB2A273J	CHIP R 27K J 1/10W		
R9			RK73FB2A153J	CHIP R 15K J 1/10W		
R10 ,11			RK73FB2A101J	CHIP R 100 J 1/10W		
R12			RK73FB2A203J	CHIP R 20K J 1/10W		
R13			RK73FB2A562J	CHIP R 5.6K J 1/10W		
R14			RK73FB2A183J	CHIP R 18K J 1/10W		
R15 ,16			RK73FB2A103J	CHIP R 10K J 1/10W		
R17 ,18			RK73FB2A153J	CHIP R 15K J 1/10W		
R19			RK73FB2A104J	CHIP R 100K J 1/10W		
R20			RK73FB2A333J	CHIP R 33K J 1/10W		
R21			RK73FB2A104J	CHIP R 100K J 1/10W		
R22			RK73FB2A105J	CHIP R 1.0M J 1/10W		
R23			RK73FB2A103J	CHIP R 10K J 1/10W		
R24 ,25			RK73FB2A332J	CHIP R 3.3K J 1/10W		
R26			RK73FB2A331J	CHIP R 330 J 1/10W		
R27			RK73FB2A105J	CHIP R 1.0M J 1/10W		
R28			RK73FB2A473J	CHIP R 47K J 1/10W		
R29			RK73FB2A154J	CHIP R 150K J 1/10W		
R30			RK73FB2A104J	CHIP R 100K J 1/10W		
R31			RK73FB2A102J	CHIP R 1.0K J 1/10W		
R32 ,33			RK73FB2A472J	CHIP R 4.7K J 1/10W		
R34			RK73FB2A104J	CHIP R 100K J 1/10W		
R35			RK73FB2A153J	CHIP R 15K J 1/10W		
R36			RK73FB2A103J	CHIP R 10K J 1/10W		
R38			RK73FB2A200J	CHIP R 20 J 1/10W		
R39 ,40			RK73FB2A133J	CHIP R 13K J 1/10W		
R41 ,42			RK73FB2A153J	CHIP R 15K J 1/10W		
R43 ,44			RK73FB2A103J	CHIP R 10K J 1/10W		
R45 ,46			RK73FB2A332J	CHIP R 3.3K J 1/10W		
R47 ,48			RK73FB2A332J	CHIP R 3.3K J 1/10W	K1P1X1	
R47 ,48			RK73FB2A332J	CHIP R 3.3K J 1/10W	T1E1	
R49 ,50			RK73FB2A822J	CHIP R 8.2K J 1/10W		
R51 ,52			RK73FB2A822J	CHIP R 8.2K J 1/10W	K1P1X1	
R51 ,52			RK73FB2A822J	CHIP R 8.2K J 1/10W	T1E1	
R53 ,54			R92-1876-05	METAL 10.5K F 1/10W		
R55 ,56			R92-1876-05	METAL 10.5K F 1/10W	K1P1X1	
R55 ,56			R92-1876-05	METAL 10.5K F 1/10W	T1E1	

L : Scandinavia K : USA P : Canada R : Mexico C : China I : Malaysia  
Y : PX(Far East, Hawaii) T : Europe E : Europe G : Germany V : China (Shanghai) K1,P1 : CD-2280M  
Y : AAFES(Europe) X : Australia Q : Russia H : Korea M : Other Areas X1,T1,E1 : DPF-J9010  
K2,P2 : CD-2260M X2 : DPF-J7010  
⚠ indicates safety critical components.

## PARTS LIST

CD-2260M/2280M/DPF-J7010/J9010



\* New Parts

Parts without **Parts No.** are not supplied.  
Les articles non mentionnés dans le **Parts No.** ne sont pas fournis.  
Teile ohne **Parts No.** werden nicht geliefert.

7

Ref. No	Add-ress	New Parts	Parts No.	Description	Desti-nation	Re-marks
R57 ,58			R92-1868-05	METAL 4.3K F 1/10W		
R59 ,60			R92-1868-05	METAL 4.3K F 1/10W	K1P1X1	
R59 ,60			R92-1868-05	METAL 4.3K F 1/10W	T1E1	
R61 ,62			RK73FB2A104J	CHIP R 100K J 1/10W		
R63 ,64			RK73FB2A104J	CHIP R 100K J 1/10W	K1P1X1	
R63 ,64			RK73FB2A104J	CHIP R 100K J 1/10W	T1E1	
R65 ,66			RK73FB2A681J	CHIP R 680 J 1/10W		
R67 ,68			RK73FB2A681J	CHIP R 680 J 1/10W	K1P1X1	
R67 ,68			RK73FB2A681J	CHIP R 680 J 1/10W	T1E1	
R69 ,70			RK73FB2A102J	CHIP R 1.0K J 1/10W		
R71 ,72			RK73FB2A102J	CHIP R 1.0K J 1/10W	K1P1X1	
R71 ,72			RK73FB2A102J	CHIP R 1.0K J 1/10W	T1E1	
R73 ,74			RK73FB2A223J	CHIP R 22K J 1/10W		
R75 ,76			RK73FB2A223J	CHIP R 22K J 1/10W	K1P1X1	
R75 ,76			RK73FB2A223J	CHIP R 22K J 1/10W	T1E1	
R77 ,78			RK73FB2A221J	CHIP R 220 J 1/10W		
R79 ,80			RK73FB2A221J	CHIP R 220 J 1/10W	K1P1X1	
R79 ,80			RK73FB2A221J	CHIP R 220 J 1/10W	T1E1	
R81			RK73FB2A222J	CHIP R 2.2K J 1/10W		
R82			RK73FB2A222J	CHIP R 2.2K J 1/10W	K1P1X1	
R82			RK73FB2A222J	CHIP R 2.2K J 1/10W	T1E1	
R83			RK73FB2A361J	CHIP R 360 J 1/10W		
R84			RS14KB3A271J	FL-PROOF RS 270 J 1W		
R85			RK73FB2A103J	CHIP R 10K J 1/10W		
R86			RK73FB2A153J	CHIP R 15K J 1/10W		
R87 ,88			RK73FB2A101J	CHIP R 100 J 1/10W		
R89			RK73FB2A103J	CHIP R 10K J 1/10W		
R90 ,91			RK73FB2A472J	CHIP R 4.7K J 1/10W		
R92			RK73FB2A2R2J	CHIP R 2.2 J 1/10W		
R93			RK73FB2A271J	CHIP R 270 J 1/10W		
R94			RK73FB2A164J	CHIP R 160K J 1/10W		
R95			RK73FB2A224J	CHIP R 220K J 1/10W		
R96 -99			RK73FB2A103J	CHIP R 10K J 1/10W		
R100,101			RK73FB2A472J	CHIP R 4.7K J 1/10W		
R102			RK73FB2A473J	CHIP R 47K J 1/10W		
R103			RK73FB2A103J	CHIP R 10K J 1/10W		
R104			RK73FB2A203J	CHIP R 20K J 1/10W	K2P2X2	
R105-107			RK73FB2A472J	CHIP R 4.7K J 1/10W		
R108			RK73FB2A473J	CHIP R 47K J 1/10W		
R109			RK73FB2A332J	CHIP R 3.3K J 1/10W		
R110,111			RK73FB2A331J	CHIP R 330 J 1/10W		
R112-115			RK73FB2A104J	CHIP R 100K J 1/10W		
R116			RK73FB2A473J	CHIP R 47K J 1/10W		
R117			RK73FB2A182J	CHIP R 1.8K J 1/10W		
R118			RK73FB2A103J	CHIP R 10K J 1/10W		
R119			RK73FB2A102J	CHIP R 1.0K J 1/10W		
R120,121			RK73FB2A331J	CHIP R 330 J 1/10W	K1P1X1	
R120,121			RK73FB2A331J	CHIP R 330 J 1/10W	T1E1	
R122-124			RK73FB2A103J	CHIP R 10K J 1/10W		
R126			RK73FB2A202J	CHIP R 2.0K J 1/10W		
R127			RK73FB2A202J	CHIP R 2.0K J 1/10W	K1P1X1	
R127			RK73FB2A202J	CHIP R 2.0K J 1/10W	T1E1	
R128			RK73FB2A512J	CHIP R 5.1K J 1/10W	K1P1X1	
R128			RK73FB2A512J	CHIP R 5.1K J 1/10W	T1E1	
R129			RK73FB2A512J	CHIP R 5.1K J 1/10W		

L : Scandinavia K : USA P : Canada R : Mexico C : China I : Malaysia  
 Y : PX(Far East, Hawaii) T : Europe E : Europe G : Germany V : China (Shanghai) X1,P1 : CD-2280M  
 Y : AAFES(Europe) X : Australia Q : Russia H : Korea M : Other Areas X1,T1,E1 : DPF-J9010  
 K2,P2 : CD-2260M X2 : DPF-J7010  
 Δ indicates safety critical components.

\* New Parts

Parts without **Parts No.** are not supplied.  
Les articles non mentionnés dans le **Parts No.** ne sont pas fournis.  
Teile ohne **Parts No.** werden nicht geliefert.

8

Ref. No	Add-ress	New Parts	Parts No.	Description	Desti-nation	Re-marks
R130			RK73FB2A103J	CHIP R 10K J 1/10W		
R131			RK73FB2A203J	CHIP R 20K J 1/10W		
R132			RK73FB2A513J	CHIP R 51K J 1/10W		
R133			RK73FB2A202J	CHIP R 2.0K J 1/10W		
R134			RK73FB2A473J	CHIP R 47K J 1/10W		
R135			RK73FB2A162J	CHIP R 1.6K J 1/10W		
R136			RK73FB2A104J	CHIP R 100K J 1/10W		
R137,138			RK73FB2A150J	CHIP R 15 J 1/10W		
R139			RK73FB2A331J	CHIP R 330 J 1/10W		
R140-143			RK73FB2A473J	CHIP R 47K J 1/10W		
R144			RK73FB2A472J	CHIP R 4.7K J 1/10W		
R145,146			RK73FB2A473J	CHIP R 47K J 1/10W		
R147			RK73FB2A103J	CHIP R 10K J 1/10W		
R148			RK73FB2A181J	CHIP R 180 J 1/10W	K1P1K2 P2	
R148			RK73FB2A181J	CHIP R 180 J 1/10W		
R149			RK73FB2A750J	CHIP R 75 J 1/10W	K1P1K2 P2	
R149			RK73FB2A750J	CHIP R 75 J 1/10W		
R150			RK73FB2A220J	CHIP R 22 J 1/10W	K1P1K2 P2	
R150			RK73FB2A220J	CHIP R 22 J 1/10W		
R151-154			RK73FB2A101J	CHIP R 100 J 1/10W	K1P1X1	
R151-154			RK73FB2A101J	CHIP R 100 J 1/10W	T1E1	
R155,156			RK73FB2A103J	CHIP R 10K J 1/10W		
R157-162			RK73FB2A103J	CHIP R 10K J 1/10W	K1P1X1	
R157-162			RK73FB2A103J	CHIP R 10K J 1/10W	T1E1	
R163,164			RK73FB2A103J	CHIP R 10K J 1/10W		
R165-168			RK73FB2A103J	CHIP R 10K J 1/10W	K1P1X1	
R165-168			RK73FB2A103J	CHIP R 10K J 1/10W	T1E1	
R169,170			RK73FB2A223J	CHIP R 22K J 1/10W	K1P1X1	
R169,170			RK73FB2A223J	CHIP R 22K J 1/10W	T1E1	
R171			RK73FB2A162J	CHIP R 1.6K J 1/10W		
R172			RK73FB2A104J	CHIP R 100K J 1/10W		
R173-178			RK73FB2A150J	CHIP R 15 J 1/10W		
R179,180			RK73FB2A564J	CHIP R 560K J 1/10W		
R181-184			RK73FB2A103J	CHIP R 10K J 1/10W		
R185-188			RK73FB2A103J	CHIP R 10K J 1/10W	K1P1X1	
R185-188			RK73FB2A103J	CHIP R 10K J 1/10W	T1E1	
R189-191			RK73FB2A102J	CHIP R 1.0K J 1/10W		
R192-194			RK73FB2A102J	CHIP R 1.0K J 1/10W	K1P1X1	
R192-194			RK73FB2A102J	CHIP R 1.0K J 1/10W	T1E1	
R195-202			RK73FB2A150J	CHIP R 15 J 1/10W		
R203			RK73FB2A200J	CHIP R 20 J 1/10W		
R204			RK73FB2A681J	CHIP R 680 J 1/10W		
VR1			R12-3101-05	TRIMMING POT.		
S1 -3			S70-0031-05	TACT SWITCH		
S4			S70-0031-05	TACT SWITCH	K1P1X1	
S4			S70-0031-05	TACT SWITCH	T1E1	
S5 -8			S70-0031-05	TACT SWITCH		
S9			S70-0031-05	TACT SWITCH	K1P1X1	
S9			S70-0031-05	TACT SWITCH	T1E1	
S10 ,11			S70-0031-05	TACT SWITCH		
S13			S62-0070-05	SLIDE SWITCH		
S14			S64-0034-05	LEVER SWITCH		
S15			S31-2132-05	SLIDE SWITCH		
S12			T99-0596-05	ROTARY ENCODER		

L : Scandinavia K : USA P : Canada R : Mexico C : China I : Malaysia  
 Y : PX(Far East, Hawaii) T : Europe E : Europe G : Germany V : China (Shanghai) X1,P1 : CD-2280M  
 Y : AAFES(Europe) X : Australia Q : Russia H : Korea M : Other Areas X1,T1,E1 : DPF-J9010  
 K2,P2 : CD-2260M X2 : DPF-J7010  
 Δ indicates safety critical components.

PARTS LIST

CD-2260M/2280M/DPF-J7010/J9010

\* New Parts  
Parts without **Parts No.** are not supplied.  
Les articles non mentionnés dans le **Parts No.** ne sont pas fournis.  
Teile ohne **Parts No.** werden nicht geliefert.

9

Ref. No	Add-ress	New Parts	Parts No.	Description	Desti-nation	Re-marks
D1 -11			HSS104	DIODE		
D1 -11			1SS133	DIODE		
D20			D3SBA20F03	DIODE		
D20			RBV-402LFA	DIODE		
D21			HZS7.5S(B2)	ZENER DIODE		
D21			RD7.5JS(B2)	ZENER DIODE		
D22			DLM10C	DIODE		
D23			HSS104	DIODE		
D23			1SS133	DIODE		
D24 ,25			S5688B	DIODE		
D24 ,25			1SR139-400	DIODE		
D26			HZS16N(B2)	ZENER DIODE		
D26			RD16ES(B2)	ZENER DIODE		
D27			HZS20N(B)	ZENER DIODE		
D27			RD20ES(B)	ZENER DIODE		
D28			HZS11N(B2)	ZENER DIODE		
D28			RD11ES(B2)	ZENER DIODE		
D29 -35			HSS104	DIODE		
D29 -35			1SS133	DIODE		
D38			HSS104	DIODE		
D38			1SS133	DIODE		
D39			HZS5.1N(B2)	ZENER DIODE		
D39			RD5.1ES(B2)	ZENER DIODE		
ED1			16-MT-63GK	INDICATOR TUBE		
ED2			16-MT-63GK	INDICATOR TUBE	K1P1X1	
ED2			16-MT-63GK	INDICATOR TUBE	T1E1	
IC1			CXA1571M	IC(CD RF AMP)		
IC2			CXD2587Q	MOS-IC		
IC3			NJM2100M	IC(OP AMPLIFIER)		
IC4			NJM2100M	IC(OP AMPLIFIER)	K1P1X1	
IC4			NJM2100M	IC(OP AMPLIFIER)	T1E1	
IC5			NJM2115M	ANALOGUE IC		
IC6			NJM2115M	ANALOGUE IC	K1P1X1	
IC6			NJM2115M	ANALOGUE IC	T1E1	
IC7			NJM2100M	IC(OP AMPLIFIER)		
IC8		*	UPD784215GF509	MI-COM IC		
IC9			5M51008BFP70LL	MEMORY IC		
IC9			628128BLFP7SL	MEMORY IC		
IC10			UPD17215GT-737	MI-COM IC		
IC11			TC74HC00AF	IC(2INPUT NAND GATE)		
IC12			TA8409S	MOS-IC		
IC13			LB1930M	ANALOGUE IC		
IC14			UPD780204-034	MI-COM IC		
IC15			UPD780204-034	MI-COM IC	K1P1X1	
IC15			UPD780204-034	MI-COM IC	T1E1	
IC16			BA5979S	ANALOGUE IC		
IC19,20			NJM2100M	IC(OP AMPLIFIER)	K1P1X1	
IC19,20			NJM2100M	IC(OP AMPLIFIER)	T1E1	
Q1			2SA954(L,K)	TRANSISTOR		
Q5 ,6			2SC3246(J,K)	TRANSISTOR		
Q7			DTC113ZSA	DIGITAL TRANSISTOR		
Q7			UN4219	DIGITAL TRANSISTOR		
Q8 ,9			DTC124ESA	DIGITAL TRANSISTOR		
Q8 ,9			UN4212	DIGITAL TRANSISTOR		
Q10			DTC124ESA	DIGITAL TRANSISTOR	K1P1X1	

L : Scandinavia K : USA P : Canada R : Mexico C : China I : Malaysia  
Y : PX(Far East, Hawaii) T : Europe E : Europe G : Germany V : China (Shanghai) X1,P1 : CD-2280M  
Y : AAFES(Europe) X : Australia Q : Russia H : Korea M : Other Areas X1,T1,E1 : DPF-J9010  
K2,P2 : CD-2260M X2 : DPF-J7010

Δ indicates safety critical components.

\* New Parts  
Parts without **Parts No.** are not supplied.  
Les articles non mentionnés dans le **Parts No.** ne sont pas fournis.  
Teile ohne **Parts No.** werden nicht geliefert.

10

Ref. No	Add-ress	New Parts	Parts No.	Description	Desti-nation	Re-marks
Q10			DTC124ESA	DIGITAL TRANSISTOR	T1E1	
Q10			UN4212	DIGITAL TRANSISTOR	K1P1X1	
Q10			UN4212	DIGITAL TRANSISTOR	T1E1	
Q11 ,12			2SA1048(Y,GR)	TRANSISTOR		
Q11 ,12			2SA1309A(Q,R)	TRANSISTOR		
Q13 ,14			2SA1048(Y,GR)	TRANSISTOR	K1P1X1	
Q13 ,14			2SA1048(Y,GR)	TRANSISTOR	T1E1	
Q13 ,14			2SA1309A(Q,R)	TRANSISTOR	K1P1X1	
Q13 ,14			2SA1309A(Q,R)	TRANSISTOR	T1E1	
Q15 ,16			2SD1450(S,T)	TRANSISTOR		
Q17 ,18			2SD1450(S,T)	TRANSISTOR	K1P1X1	
Q17 ,18			2SD1450(S,T)	TRANSISTOR	T1E1	
Q19			2SK246(Y)	FET		
Q20			2SB1143(S,T)	TRANSISTOR		
Q21			2SC3940A	TRANSISTOR		
Q22			2SA954(L,K)	TRANSISTOR		
Q23			DTC124EUA	DIGITAL TRANSISTOR		
Q23			UN5212	DIGITAL TRANSISTOR		
Q24			DTA124EUA	DIGITAL TRANSISTOR		
Q24			UN5112	DIGITAL TRANSISTOR		
Q25			2SB1417(P)	TRANSISTOR		
Q25			2SB1640	TRANSISTOR		
Q26			2SC2003(L,K)	TRANSISTOR		
Q27			DTA113ZSA	DIGITAL TRANSISTOR		
Q27			UN4119	DIGITAL TRANSISTOR		
Q29			2SC2458(Y,GR)	TRANSISTOR	K1P1K2	
Q29			2SC2458(Y,GR)	TRANSISTOR	P2	
Q29			2SC3311A(Q,R)	TRANSISTOR	K1P1K2	
Q29			2SC3311A(Q,R)	TRANSISTOR	P2	
Q29			2SA1048(Y,GR)	TRANSISTOR	K1P1K2	
Q30			2SA1048(Y,GR)	TRANSISTOR	P2	
Q30			2SA1309A(Q,R)	TRANSISTOR	K1P1K2	
Q30			2SA1309A(Q,R)	TRANSISTOR	P2	
Q31 ,32			2SA954(L,K)	TRANSISTOR	K1P1X1	
Q31 ,32			2SA954(L,K)	TRANSISTOR	T1E1	
Q33 ,34			DTC124ESA	DIGITAL TRANSISTOR	K1P1X1	
Q33 ,34			DTC124ESA	DIGITAL TRANSISTOR	T1E1	
Q33 ,34			UN4212	DIGITAL TRANSISTOR	K1P1X1	
Q33 ,34			UN4212	DIGITAL TRANSISTOR	T1E1	
Q35			2SC2458(Y,GR)	TRANSISTOR		
Q35			2SC3311A(Q,R)	TRANSISTOR		
A1	2D		W02-2561-05	ELECTRIC CIRCUIT MODULE		
A2			W02-1114-05	OSCILLATING MODULE	X1T1E1	
A2			W02-1114-05	OSCILLATING MODULE	X2	
<b>MECHANISM (W03-5571-05)</b>						
1	1E		A11-1134-08	BASE ARM		
2	1E		D10-3788-08	LEVER R		
3	1D		D12-0158-08	CAM CHANGE		
4	1E		J19-5892-08	HOLDER ARM		
5	1E		G16-0912-08	RUBBER		
6	1E		D10-3778-08	ARM DISC		
7	1E		G01-4060-08	SPG DISC H		
8	1E		J21-6576-08	PLATE ARM		
9	1E		D10-3785-08	SLIDER RACK		

L : Scandinavia K : USA P : Canada R : Mexico C : China I : Malaysia  
Y : PX(Far East, Hawaii) T : Europe E : Europe G : Germany V : China (Shanghai) X1,P1 : CD-2280M  
Y : AAFES(Europe) X : Australia Q : Russia H : Korea M : Other Areas X1,T1,E1 : DPF-J9010  
K2,P2 : CD-2260M X2 : DPF-J7010

Δ indicates safety critical components.

\* New Parts

Parts without **Parts No.** are not supplied.

Les articles non mentionnés dans le **Parts No.** ne sont pas fournis.

Teile ohne **Parts No.** werden nicht geliefert.

11

Ref. No	Add-ress	New Parts	Parts No.	Description	Desti-nation	Re-marks
10	1E		J19-5891-08	HOLDER RACK		
12	1D		D10-3787-08	LEVER CHANGE		
14	1E,2D		T42-0920-08	MOTOR		
17	1D		D13-1856-08	GEAR D		
19	1E		D10-3781-08	LEVER HOOK A		
20	1E		D10-3782-08	LEVER HOOK B		
21	1D		D13-1857-08	GEAR E		
22	1D		S64-0038-08	LEVER SW		
24	1E		G01-4066-08	SPG LIMITER		
25	1E		J21-6579-08	PLATE LIMITER		
26	2E		D10-3779-08	ARM SWING		
27	2E		D13-1855-08	GEAR CAM		
28	2D		G01-4067-08	SPG CHASSIS SUB		
29	2D		J21-6573-08	PLATE LOCK		
30	2D		G01-4061-08	SPG LOCK LEVER		
31	2E		D10-3780-08	SLIDER CAM		
32	2E		J21-6574-08	PLATE SLIDE		
33	2E		D13-1854-08	GEAR SLIDER		
34	2E		D10-3786-08	LEVER STOPPER		
37	2E		J90-0854-08	GUIDE RACK		
38	1D		G01-4064-08	SPG CHANGE		
39	2D		D21-1899-08	PIN ROLLER		
40	2D		D14-0393-08	HOLDER ROLLER		
41	2D		J19-5888-08	ROLLER GUIDE		
42	2D		D21-1900-08	SHAFT MAIN		
43	2D		J19-5890-08	HOLDER SHAFT		
44	2D		J90-0856-08	GUIDE DISC		
45	1D		D32-0354-08	STOPPER DISC		
46	1D		J19-5893-08	HOLDER SENSOR		
47	1D		J19-5927-08	HOLDER SENSOR		
49	2E		J21-6570-08	PLATE HOLD T		
55	2E		J21-6580-08	PLATE LINK		
58	2E		J21-6571-08	PLATE SLIDER A		
60	2E		J21-6575-08	PLATE SUPPORT B		
62	2D		D13-1852-08	GEAR B		
63	2D		D13-1853-08	GEAR C		
64	1E		J90-0855-08	GUIDE DISC U		
65	2E		J19-5894-08	HOLDER DISC U		
67	2E		G01-4057-08	SPG SLIDER		
68	2E		G01-4058-08	SPG HOLD MAGNET		
69	1E		G01-4062-08	SPG DAMPER A		
70	2E		G01-4063-08	SPG DAMPER B		
71	2E		G01-4059-08	SPG PLATE ARM		
72	2E		G01-4065-08	SPG STOPPER		
73	1D		J19-5889-08	STOCKER ROTARY		
80	2E		J11-0827-08	CLAMPER		
82	2E		J02-1412-08	INSULATOR		
83	1D		E40-8285-08	CONNECTOR 5P		
86	2E		T99-0565-05	MAGNET		
87	1D		N29-0287-08	E-RING 6.0		
88	1D		N19-1458-08	PSW 8.5X16X0.5		
89	2D		N19-1460-08	PSW 8.5X30X0.5		
90	2E		J69-0083-04	DOUBLE COATED TAPE		
91	2E		T95-0160-08	PHOTO INTERRUPTER		
92	2E		E40-8284-08	CONNECTOR 5P		

L : Scandinavia  
Y : PX(Far East, Hawaii)  
Y : AAFES(Europe)

K : USA  
T : Europe  
X : Australia

P : Canada  
E : Europe  
Q : Russia

R : Mexico  
G : Germany  
H : Korea

C : China  
V : China (Shanghai)  
M : Other Areas

I : Malaysia  
K1,P1 : CD-2280M  
X1,T1,E1 : DPF-J9010  
K2,P2 : CD-2260M X2 : DPF-J7010  
Δ indicates safety critical components.

\* New Parts

Parts without **Parts No.** are not supplied.

Les articles non mentionnés dans le **Parts No.** ne sont pas fournis.

Teile ohne **Parts No.** werden nicht geliefert.

12

Ref. No	Add-ress	New Parts	Parts No.	Description	Desti-nation	Re-marks
94	2E		N19-1461-08	FLAT WASHER		
-			B20-0623-18	SCALE		
-			B20-0624-08	SCALE		
-			B20-0625-08	SCALE		
-			B20-0626-08	SCALE		
LED			SIM-20ST	LED		
TR			RPM-20PB	TRANSISTOR		
R			RK73FB2A471J	CHIP R	470 J 1/10W	
<b>TRAVERSE (D40-1515-05)</b>						
3	2A		D10-3606-08	ROD		
4	1B		D13-1720-08	GEAR		
6	3B		S74-0038-08	LEAF SWITCH		
8	3B		E40-3264-05	PIN ASSY		
DM	1B		A11-1082-18	SUB CHASSIS ASSY		
FM	2B		T42-0817-08	MOTOR ASSY		
PU	1A		T25-0055-08	OPTICAL PICKUP(KSS-213C)		

L : Scandinavia  
Y : PX(Far East, Hawaii)  
Y : AAFES(Europe)

K : USA  
T : Europe  
X : Australia

P : Canada  
E : Europe  
Q : Russia

R : Mexico  
G : Germany  
H : Korea

C : China  
V : China (Shanghai)  
M : Other Areas

I : Malaysia  
K1,P1 : CD-2280M  
X1,T1,E1 : DPF-J9010  
K2,P2 : CD-2260M X2 : DPF-J7010  
Δ indicates safety critical components.

#### HOW TO READ THE PARTS LIST

#### ABBREVIATION OF MODEL AND MASS PRODUCTION'S DESTINATIONS

MODEL	ABB.	Australia	Canada	China	England	Europe	Germany	Korea	Malaysia
CD-2260M	-		P2	-	-	-	-	-	-
DPF-J7010	-	X2	-	-	-	-	-	-	-
CD-2280M	-	-	P1	-	-	-	-	-	-
DPF-J9010	-	X1	-	-	T1	E1	-	-	-
MODEL	ABB.	Mexico	PX/AAFES	Russia	Scandinavia	Shanghai	U.S.A.	Other area	
CD-2260M	-	-	-	-	-	-	K2	-	-
DPF-J7010	-	-	-	-	-	-	-	-	-
CD-2280M	-	-	-	-	-	-	K1	-	-
DPF-J9010	-	-	-	-	-	-	-	-	-

PARTS LIST

CD-2260M/2280M/DPF-J7010/J9010

# CD-2260M/2280M/DPF-J7010/J9010

## SPECIFICATIONS

### CD-2260M/DPF-J7010

#### [Format]

System ..... Compact disc digital audio system  
Laser ..... Semiconductor laser

#### [D/A Convertors]

D/A Conversion ..... 1 Bit  
Oversampling ..... 8 fs (352.8 kHz)

#### [Audio]

Frequency response ..... 4 Hz ~ 20 kHz,  $\pm 0.5$  dB  
Signal to noise ratio ..... More than 97 dB  
Dynamic range ..... More than 94 dB  
Total harmonic distortion + noise

..... Less than 0.005% (at 1 kHz)

Channel separation ..... More than 92 dB (at 1 kHz)

Wow & flutter ..... Unmeasurable Limit

#### Output level/impedance

Fixed ..... 2.0 V/0.9 k $\Omega$

#### Digital output

Coxial (CD-2260M only) ..... 0.5 Vp-p/75  $\Omega$

Optical (DPF-J7010 only) ..... -15 dBm ~ -21 dBm  
(Wave length 660 nm)

#### [General]

Power consumption ..... 13 W

Dimensions ..... W : 440 mm (17-5/16")  
H : 176 mm (6-15/16")  
D : 479 mm (18-7/8")

Weight (Net) ..... 7.9 kg (17.4 lb)

### CD-2280M/DPF-J9010

#### [Format]

System ..... Compact disc digital audio system  
Laser ..... Semiconductor laser

#### [D/A Convertors]

D/A Conversion ..... 1 Bit  
Oversampling ..... 8 fs (352.8 kHz)

#### [Audio]

Frequency response ..... 4 Hz ~ 20 kHz,  $\pm 0.5$  dB  
Signal to noise ratio ..... More than 97 dB  
Dynamic range ..... More than 94 dB  
Total harmonic distortion + noise

..... Less than 0.005% (at 1 kHz)

Channel separation ..... More than 92 dB (at 1 kHz)

Wow & flutter ..... Unmeasurable Limit

#### Output level/impedance

Fixed ..... 2.0 V/0.9 k $\Omega$

#### Digital output

Coxial (CD-2280M only) ..... 0.5 Vp-p/75  $\Omega$

Optical (DPF-J9010 only) ..... -15 dBm ~ -21 dBm  
(Wave length 660 nm)

#### [General]

Power consumption ..... 14 W

Dimensions ..... W : 440 mm (17-5/16")  
H : 176 mm (6-15/16")  
D : 479 mm (18-7/8")

Weight (Net) ..... 9.0 kg (19.8 lb)



1. KENWOOD follows a policy of continuous advancements in development. For this reason specifications may be changed without notice.
2. The full performance may not be exhibited in an extremely cold location (under a water-freezing temperature).

#### Note:

Component and circuit are subject to modification to insure best operation under differing local conditions. This manual is based on U.S.A. (K) standard, and provides information on regional circuit modification through use of alternate schematic diagrams, and information on regional component variations through use of parts list.

## KENWOOD CORPORATION

14-6, Dogenzaka 1-chome, Shibuya-ku, Tokyo, 150 Japan

### KENWOOD SERVICE CORPORATION

P.O. BOX 22745, 2201 East Dominguez St., Long Beach, CA 90801-5745, U.S.A.

### KENWOOD ELECTRONICS CANADA INC.

6070 Kestrel Road, Mississauga, Ontario, Canada L5T 1S8

### KENWOOD ELECTRONICS LATIN AMERICA S.A.

P.O. BOX 55-2791, Piso 6 plaza Chase, Cl. 47 y Aquilino de la Guardia Panama, Republic de Panama

### KENWOOD ELECTRONICS BRASIL LTDA.

Av Indianópolis, 628, 04062-001 Planalto Paullista São Paulo-SP-Brasil

### KENWOOD ELECTRONICS U.K. LIMITED

KENWOOD House, Dwight Road, Watford, Herts., WD1 8EB., United Kingdom

### KENWOOD ELECTRONICS BELGUM N.V.

Meachelsesteenweg 418, B-1930 Zaventem, Belgium

### KENWOOD ELECTRONICS DEUTSCHLAND GMBH

Rembrücker Str. 15, 63150 Heusenstamm, Germany

### KENWOOD ELECTRONICS FRANCE S.A.

13 Boulevard Ney, 75018 Paris, France

### KENWOOD ELECTRONICS ITALIA S.p.A.

Via G. Sirtori, 7/9 20129, Milano, Italy

### KENWOOD IBÉRICA S.A.

Bolivia, 239-08020 Barcelona, Spain

### KENWOOD ELECTRONICS AUSTRALIA PTY. LTD.

(A.C.N. 001499 074)

P.O. Box 504, 8 Figtree Drive, Australia Centre, Homebush, N.S.W. 2140, Australia

### KENWOOD & LEE ELECTRONICS, LTD.

Unit 3712-3724, Level 37, Tower 1, Metroplaza, 223 Hing Fong Road, Kwai Fong N.T., Hong Kong

### KENWOOD ELECTRONICS GULF FZE

P.O. Box 61318, Jebel Ali, Dubai, U.A.E.

### KENWOOD ELECTRONICS SINGAPORE PTE LTD.

No. 1 Genting Lane #02-02, KENWOOD Building, Singapore, 349544

### KENWOOD ELECTRONICS (MALAYSIA) SDN BHD.

#4.01 Level 4, Wisma Academy Lot 4A, Jalan 19/1 46300 Petaling Jaya Selangor Darul Ehsan Malaysia

### KENWOOD ELECTRONICS (THAILAND) CO., LTD.

573/111 Soi Ramkhamhaeng 39, Ramkhamhaeng Road, Wangthonglang, Bangkok, Bangkok 10301 Thailand